



***BRIDGESTONE***

**TRUCK TIRE  
DATA BOOK**

**2018**

**VERSION 18.1**



## 2018 Tire Data Book Medium & Light Truck

### TABLE OF CONTENTS

<b>Recommended Medium Truck Tire Application</b> .....	2
<b>Medium Truck Tire Size &amp; Availability Chart</b> .....	4 - 5
<b>Medium Truck Tires</b> .....	2 - 45
<i>Medium Truck Tire – Discontinued Products</i> .....	42 - 45
<b>Commercial Light Truck Tires</b> .....	47 - 57
<b>Light Truck Tire Size &amp; Availability Chart</b> .....	48
<i>Commercial Light Truck Tire – Discontinued Products</i> .....	56 - 57
<b>General Technical Information</b> .....	59 - 90
<b>Load &amp; Inflation Tables</b> .....	91 - 98
<b>Technical Bulletins</b> .....	99 - 113
<b>Truck Tire Comparison Guide</b> .....	114 - 116

# Recommended Medium Truck Tire Application

SERVICE	BRIDGESTONE	PAGE	STEER AXLE	DRIVE AXLE		TRAILER AXLE	
				SINGLE	TANDEM	TANDEM	SPREAD
Long Haul	Greatec® M835A Ecopia®	18			■		
	Greatec® R197 Ecopia®	27				■	
Long Haul Regional Haul	R283A Ecopia®	6	■	▲	▲	▲	
	R283S Ecopia®	7	■	▲	▲	▲	
	R227F	8	■	▲	▲	▲	
	M710 Ecopia®	12		▲	■		
	R197 Ecopia®	24	▲			■	▲
Auto Haulers Long Haul Regional Haul	M749	17		■	■		
Long Haul Regional Haul Local / Pickup & Delivery	M760 Ecopia®	13		■	■		
	M726 ELA	14		■	■		
	M726	15		■	■		
	M770	19		■			
	M729F	21		■	■		
	M724F	23	■	■	■	▲	
	R196	25	▲			▲	■
Regional Haul Local / Pickup & Delivery	R268 Ecopia®	9	■	▲	▲	▲	▲
	R238	10	■	▲	▲	▲	▲
	R244	38		■		■	
Local / Pickup & Delivery	M895	22		■	■		
	R180	28	■	▲	▲	▲	
Regional Haul High-Scrub Urban	Greatec® M845	29		■		■	
Regional Haul High-Scrub / Pickup & Delivery	M860A	31	■	▲	▲	▲	
Regional Haul High-Scrub / Pickup & Delivery Off-Highway	M799	20		■	■		
	R250 ED	11	■	▲	▲	▲	▲
On/Off-Highway	M853	32	■	■	■	■	
	M843	33	■	■	■	■	
	M840	34	■	■	■	■	
	M857	35	■	▲	▲	▲	
	L320	36		■	■		
	M854	39	▲	■	■	▲	
	L315	40	■	■	■		
Severe On/Off-Highway	M775	37		■			
	Greatec® M853	30		■		■	
Off-Highway	L317	41		■	■		

SLOWER TIRE WEAR

FASTER TIRE WEAR

Long Haul Service | Regional Haul Service | Local / Pickup & Delivery Service | On/Off-Highway Service

## Medium Truck Tires

<b>R283A Ecopia® Fuel-Efficient All-Position Tire</b> .....	6
<b>R283S Ecopia® Fuel-Efficient Steer Tire</b> .....	7
<b>R227F All-Position Tire</b> .....	8
<b>R268 Ecopia® Fuel-Efficient All-Position Tire</b> .....	9
<b>R238 All-Position Tire</b> .....	10
<b>R250 ED All-Position Tire</b> .....	11
<b>M710 Ecopia® Fuel-Efficient Drive Tire</b> .....	12
<b>M760 Ecopia® Fuel-Efficient Drive Tire</b> .....	13
<b>M726 ELA Drive Tire</b> .....	14
<b>M726 Drive Tire</b> .....	15
<b>M749 Drive Tire</b> .....	17
<b>Greatec® M835A Ecopia® Fuel-Efficient Wide Base Drive Tire</b> .....	18
<b>M770 Drive Tire</b> .....	19
<b>M799 Drive Tire</b> .....	20
<b>M729F Drive Tire</b> .....	21
<b>M895 Metro All-Position Tire</b> .....	22
<b>M724F Metro All-Position Tire</b> .....	23
<b>R197 Ecopia® Fuel-Efficient All-Position Tire</b> .....	24
<b>R196 All-Position High-Scrub Tire</b> .....	25
<b>Greatec® R197 Ecopia® Fuel-Efficient Wide Base Trailer Tire</b> .....	27
<b>R180 All-Position Tire</b> .....	28
<b>Greatec® M845 Wide Base All-Position Tire</b> .....	29
<b>Greatec® M853 On/Off-Highway Wide Base All-Position Tire</b> .....	30
<b>M860A High Scrub All-Position Tire</b> .....	31
<b>M853 On/Off-Highway All-Position Tire</b> .....	32
<b>M843 On/Off-Highway All-Position Tire</b> .....	33
<b>M840 On/Off-Highway All-Position Tire</b> .....	34
<b>M857 On/Off-Highway All-Position Tire</b> .....	35
<b>L320 On/Off-Highway Drive Axle Tire</b> .....	36
<b>M775 On/Off-Highway Drive Axle Tire</b> .....	37
<b>R244 On/Off-Highway Wide Base All-Position Tire</b> .....	38
<b>M854 On/Off-Highway Wide Base All-Position Tire</b> .....	39
<b>L315 On/Off-Highway Wide Base Drive Axle Tire</b> .....	40
<b>L317 Off-Highway Drive Axle Tire</b> .....	41
<b>Medium Truck Tire – Discontinued Products</b> .....	42 - 45

# Medium Truck Tire Size & Availability Charts

LOAD RANGE & TREAD DEPTHS IN 32NDS INDICATE AVAILABILITY

BRIDGESTONE	R283A Ecopia®	R283S Ecopia®	R227F	R268 Ecopia®	R238	R250 ED	M710 Ecopia®	M760 Ecopia®	M726 ELA	M726	M749	Greatec® M835A Ecopia®	M770	M799	M729F	M895	M724F
SmartWay® Verified & CARB Compliant	■	■		■			■	■				■					
PAGE	6	7	8	9	10	11	12	13	14	15	17	18	19	20	21	22	23
REPLACES GOODYEAR	Fuel Max LHS	Fuel Max LHS	-	G662, G661	G647, Endurance RSA	G661, G662	G505D, G305	G572A	G362, G622RSD	G622	-	G392 SSD	G338	G182	G622	G622	G622, G633
REPLACES MICHELIN	XZA3+, XLine EnergyZ	XZA3+, XLine EnergyZ	XZA, XZE2+	XZE, XZE2, XZE2+, XMulti EnergyZ	XZE	XZE, XZE2, XZE2+	XDA Energy, XLine Energy D	X Multi Energy D	XDA5, XDN2	XD2	X Multi-Way XD	X One Line Energy D	XD4, XDN2, XDE M/S	XDE M/S	XDE2+, XDS2	XDS2	XDS2, XDE2+
<b>SIZE</b>	<b>LOAD RANGE - TREAD DEPTH</b>																
11.00R24																	
12.00R24																	
9R17.5																	
8R19.5																	F-20
9R22.5				F-19													
10R22.5				F/G-20					G-26								
11R22.5	G/H-18	H-18		G/H-21		H-19	G-26	G-27	G-32				G/H-31	H-28			
12R22.5				H-21										H-30			
11R24.5	G/H-18	H-18		G/H-21		H-19	G-26	G-27	G/H-32				G-31	H-28			
12R24.5																	
215/75R17.5					G/H-15										F-22		
245/70R17.5					J-17												
225/70R19.5					F/G-16										F/G-19	F-17	F-20
245/70R19.5					F/G/H-18										H-19	G-17	H-21
265/70R19.5					G-17										G-19		
285/70R19.5			H-17												H-20		
305/70R19.5			J-18														
245/75R22.5				G-15													
255/70R22.5						H-18				H-26							
265/75R22.5				G-21													
275/70R22.5						J-19											
295/60R22.5											J-22						
295/75R22.5	G/H-18	H-18		G-21			G-26	G-27	G-32				G-31				
295/80R22.5				H-21													
305/70R22.5																	
315/80R22.5																	
385/65R22.5																	
425/65R22.5																	
445/50R22.5												L-23					
445/65R22.5																	
455/55R22.5																	
285/75R24.5	G-18	H-18		G-21			G-26	G-27	G-32				G-31				

# Medium Truck Tire Size & Availability Charts

LOAD RANGE & TREAD DEPTHS IN 32NDS INDICATE AVAILABILITY

BRIDGESTONE	R197 Ecopia <sup>®</sup>	R196	Greatec <sup>®</sup> R197 Ecopia <sup>®</sup>	R180	Greatec <sup>®</sup> M845	Greatec <sup>®</sup> M853	M860A	M853	M843	M840	M857	L320	M775	R244	M854	L315	L317 <sup>†</sup>
SmartWay <sup>®</sup> Verified & CARB Compliant	■		■														
PAGE	24	25	27	28	29	30	31	32	33	34	35	36	37	38	39	40	41
REPLACES GOODYEAR	G316 LHT, LHT	G619, G661	G394 SST	G114	-		G287, G289	G287, G289	G287, G288	G288	G286	G177, G282	G177, G282	G296 MSA	G296	G178, G286, G296	G177
REPLACES MICHELIN	XLine EnergyT	XTE	X One Line Energy T	XZA	X One XZUS	X One XZUS	XZUS2, XZUS, XZY3	XZY3	XDS, XDS2	XZY, XTY2	-	XDY3, XDY-EX2, XDL	XDY-EX2, XDY3, XDY-2	XFE	XZY3	XZY3	XDL, XZL
SIZE	LOAD RANGE - TREAD DEPTH																
11.00R24											H-20						
12.00R24										J-23		J-31					J-39†
9R17.5				G-14													
8R19.5																	
9R22.5																	
10R22.5																	
11R22.5	G-11	G-16						H-25	G/H-26			G/H-31	H-33				
12R22.5								H-25	H-26			H-31	H-34				
11R24.5	G-11	G-16						H-25	G/H-26			G/H-31	H-33				
12R24.5									H-27								
215/75R17.5																	
245/70R17.5																	
225/70R19.5																	
245/70R19.5																	
265/70R19.5																	
285/70R19.5																	
305/70R19.5																	
245/75R22.5																	
255/70R22.5																	
265/75R22.5																	
275/70R22.5										J-22							
295/60R22.5																	
295/75R22.5	G-11	G-16															
295/80R22.5																	
305/70R22.5																	
315/80R22.5							L-24		L-26								
385/65R22.5														L-21	J-23	J-30	
425/65R22.5							L-23							L-21	L-23	L-30	
445/50R22.5			L-11														
445/65R22.5														M-21	M-23	L-30	
455/55R22.5					M-23	M-23											
285/75R24.5	G-11	G-16															

† Not for highway use.



**BRIDGESTONE**  
Your Journey, Our Passion

## R283A Ecopia®

Fuel-Efficient All-Position Radial



- Tread cap compound and solid shoulder ribs enhance resistance to maneuvering scrub, leading to increased tread life.
- Stone rejectors in center grooves help provide resistance to stone drilling and protect belts for enhanced casing durability.
- Stress relief sipes fight irregular wear by absorbing rib edge stresses in the footprint for long, even wear.
- Sidewall protector ribs help protect the casing from cuts, snags and abrasions due to curbing and impacts.
- Innovative sidewall design reduces overall weight to improve fuel efficiency without sacrificing durability.

EPA SmartWay® verified  
and CARB compliant.

### Recommended Application

An all-position tire recommended for steer applications in:  
**Long Haul Service / Regional Haul Service**

**Replaces:** Goodyear: Fuel Max LHS  
Michelin: XZA3+, X Line Energy Z

### TECHNICAL DATA

Tire Size	Load Range	Material Number	Weight (lbs.)	Meas. Rim	Overall Diam.	Overall Width	Static Loaded Radius	Overall Width (Loaded)	Revs Per Mile	Tread Depth (32')	Max. Tire Load (Single)		Max. Tire Load (Dual)		Max. Speed (MPH)
											Kg/kPa	Lbs/PSI	Kg/kPa	Lbs/PSI	
<b>R283A Ecopia®</b>															
11R22.5	G	004-104	116	8.25	41.1	11.5	19.2	12.7	505	18	2800@720	6175@105	2650@720	5840@105	75
11R22.5	H	004-105	116	8.25	41.1	11.5	19.2	12.7	505	18	3000@830	6610@120	2725@830	6005@120	75
11R24.5	G	004-106	124	8.25	43.1	11.5	20.1	12.7	482	18	3000@720	6610@105	2725@720	6005@105	75
11R24.5	H	004-107	124	8.25	43.1	11.5	20.1	12.7	482	18	3250@830	7160@120	3000@830	6610@120	75
295/75R22.5	G	004-100	114	8.25	40.3	11.4	18.8	12.5	516	18	2800@760	6175@110	2575@760	5675@110	75
295/75R22.5	H	004-101	114	8.25	40.3	11.4	18.8	12.5	516	18	3250@830	7160@120	3000@830	6610@120	75
285/75R24.5	G	004-102	118	8.25	41.3	11.4	19.4	12.5	503	18	2800@760	6175@110	2575@760	5675@110	75
285/75R24.5	H	004-103	118	8.25	41.3	11.4	19.4	12.5	503	18	3075@830	6780@120	2800@830	6175@120	75

- All dimensions taken with tire on measuring rim.
- Loaded dimensions and RPM measured at maximum dual load.
- For load and inflation tables see pages 91 through 96.
- For minimum dual spacing and approved rim widths see page 74.
- For ply ratings see table on page 72.

- Based on rolling resistance and field mileage tests, Bridgestone Ecopia and Bandag FuelTech are our most fuel-efficient and lowest total cost of ownership tire and retread solution. Combining proprietary low rolling resistance technology with the industry's most retreadable casing, Ecopia and FuelTech can help reduce fuel use and extend tire life for lower costs and greener returns, when compared to other Bridgestone tires.
- BASys® data from over two million Bridgestone, Goodyear and Michelin brand casings recorded between June 2009 and November 2010 prove that Bridgestone had the lowest percentage of tires that could not be retreaded due to conditions relating to casing construction.

Bridgestone tires and tubes are subject to an ongoing development program. Bridgestone Americas Tire Operations, LLC retains the right to amend specifications at any time without notice or obligations. Please refer to rim manufacturer's load and inflation limits. Never exceed rim manufacturer's limits without the consent of the component manufacturer.



**BRIDGESTONE**  
Your Journey, Our Passion

## R283s Ecopia®

Fuel-Efficient Steer Radial



- Tread cap compound and NanoPro-Tech polymer improves rolling resistance to maneuvering scrub, leading to increased tread life.
- Defense side groove and solid shoulder ribs optimize footprint for longer original life and even wear.
- Stone rejectors in center grooves help provide resistance to stone drilling and protect belts for enhanced casing durability.
- Stress relief sipes fight irregular wear by absorbing rib edge stresses in the footprint for long, even wear.
- Fuel saver sidewall reduces heat generation and energy loss.
- IntelliShape™ sidewall design reduces overall weight to improve fuel efficiency without sacrificing durability.

EPA SmartWay® verified  
and CARB compliant.

### Recommended Application

An all-position tire recommended for steer applications in:  
**Long Haul Service / Super-Regional Haul Service**

**Replaces:** Goodyear: Fuel Max LHS  
Michelin: XZA3+, X Line Energy Z

### TECHNICAL DATA

Tire Size	Load Range	Material Number	Weight (lbs.)	Meas. Rim	Overall Diam.	Overall Width	Static Loaded Radius	Overall Width (Loaded)	Revs Per Mile	Tread Depth (32")	Max. Tire Load (Single)		Max. Tire Load (Dual)		Max. Speed (MPH)
											Kg/kPa	Lbs/PSI	Kg/kPa	Lbs/PSI	
<b>R283s Ecopia®</b>															
11R22.5	H	008-831	116	8.25	41.1	11.5	19.2	12.7	505	18	3000@830	6610@120	2725@830	6005@120	75
11R24.5	H	008-832	124	8.25	43.1	11.5	20.1	12.7	482	18	3250@830	7160@120	3000@830	6610@120	75
295/75R22.5	H	008-829	114	8.25	40.3	11.4	18.8	12.5	516	18	3250@830	7160@120	3000@830	6610@120	75
285/75R24.5	H	008-830	118	8.25	41.3	11.4	19.4	12.5	503	18	3075@830	6780@120	2800@830	6175@120	75

- All dimensions taken with tire on measuring rim.
- Loaded dimensions and RPM measured at maximum dual load.
- For load and inflation tables see pages 91 through 96.
- For minimum dual spacing and approved rim widths see page 74.
- For ply ratings see table on page 72.

- Based on rolling resistance and field mileage tests, Bridgestone Ecopia and Bandag FuelTech are our most fuel-efficient and lowest total cost of ownership tire and retread solution. Combining proprietary low rolling resistance technology with the industry's most retreadable casing, Ecopia and FuelTech can help reduce fuel use and extend tire life for lower costs and greener returns, when compared to other Bridgestone tires.
- BASys® data from over two million Bridgestone, Goodyear and Michelin brand casings recorded between June 2009 and November 2010 prove that Bridgestone had the lowest percentage of tires that could not be retreaded due to conditions relating to casing construction.

Bridgestone tires and tubes are subject to an ongoing development program. Bridgestone Americas Tire Operations, LLC retains the right to amend specifications at any time without notice or obligations. Please refer to rim manufacturer's load and inflation limits. Never exceed rim manufacturer's limits without the consent of the component manufacturer.





**BRIDGESTONE**  
Your Journey, Our Passion

## R227F

All-Position Radial

- Directional pattern and high-performance tread compound for long wear and reliable wet traction.
- Sidewall protectors for extra protection from curb damage.
- Defense Groove™ and Equalizer Rib™ features combat the initiation and spread of irregular wear.
- Stress relief sipes fight the initiation and spread of irregular wear on the main ribs by absorbing rib edge stresses within the footprint.

### Recommended Application

An all-position tire recommended for steering applications in:  
**Long Haul Service / Regional Haul Service**

*Replaces:* Michelin: XZA, XZE2+

### TECHNICAL DATA

Tire Size	Load Range	Material Number	Weight (lbs.)	Meas. Rim	Overall Diam.	Overall Width	Static Loaded Radius	Overall Width (Loaded)	Revs Per Mile	Tread Depth (32")	Max. Tire Load (Single)		Max. Tire Load (Dual)		Max. Speed (MPH)
											Kg/kPa	Lbs/PSI	Kg/kPa	Lbs/PSI	
<b>R227F</b>															
285/70R19.5	H	158-135	93	8.25	35.3	10.6	16.3	11.6	588	17	2900@860	6395@125	2725@860	6005@125	75
305/70R19.5	J	158-948	120	9.00	36.3	11.9	16.7	13.0	572	18	3150@860	6945@125	2900@860	6395@125	75

- All dimensions taken with tire on measuring rim.
- Loaded dimensions and RPM measured at maximum dual load.
- For load and inflation tables see pages 91 through 96.
- For minimum dual spacing and approved rim widths see page 74.
- For ply ratings see table on page 72.

Bridgestone tires and tubes are subject to an ongoing development program. Bridgestone Americas Tire Operations, LLC retains the right to amend specifications at any time without notice or obligations. Please refer to rim manufacturer's load and inflation limits. Never exceed rim manufacturer's limits without the consent of the component manufacturer.



**BRIDGESTONE**  
Your Journey, Our Passion

## R268 Ecopia®

Fuel-Efficient All-Position Radial



- Waved channel design reduces groove bottom strain, combating the initiation and spread of irregular wear.
- Optimized rib distribution uniquely proportioned for added stiffness, which helps reduce irregular wear throughout the footprint.
- Patented NanoPro-Tech™ polymer technology limits energy loss for improved rolling resistance and optimum fuel efficiency.
- Wide, solid shoulder ribs help deliver enhanced resistance to maneuvering scrub and increased tread life.

### Recommended Application

Recommended for high traction and high scrub applications in:  
**Regional Haul Service / Pickup & Delivery Service**

**Replaces:** Goodyear: G662, G661  
Michelin: XZE, XZE2, XZE2+, X Multi Energy Z

EPA SmartWay® verified  
and CARB compliant.

### TECHNICAL DATA

Tire Size	Load Range	Material Number	Weight* (lbs.)	Meas. Rim	Overall Diam.	Overall Width	Static Loaded Radius	Overall Width (Loaded)	Revs Per Mile	Tread Depth (32")	Max. Tire Load (Single)		Max. Tire Load (Dual)		Max. Speed (MPH)
											Kg/kPa	Lbs/PSI	Kg/kPa	Lbs/PSI	
<b>R268 Ecopia</b>															
9R22.5	F	000-275	90	6.75	38.4	8.9	18.0	9.8	541	19	2060@720	4540@105	1950@720	4300@105	75
10R22.5	F	000-276	109	7.50	40.2	9.9	18.8	10.9	517	20	2360@690	5205@100	2240@690	4940@100	75
10R22.5	G	000-277	110	7.50	40.2	9.9	18.8	10.9	517	20	2575@790	5675@115	2430@790	5355@115	75
11R22.5	G	248-783	122	8.25	41.5	11.2	19.3	12.3	500	21	2800@720	6175@105	2650@720	5840@105	75
11R22.5	H	248-817	122	8.25	41.5	11.2	19.3	12.3	500	21	3000@830	6610@120	2725@830	6005@120	75
12R22.5	H	000-278	139	9.00	42.7	11.6	19.9	12.8	486	21	3350@830	7390@120	3075@830	6780@120	75
11R24.5	G	248-834	136	8.25	43.5	11.2	20.3	12.3	477	21	3000@720	6610@105	2725@720	6005@105	75
11R24.5	H	248-868	136	8.25	43.6	11.2	20.3	12.3	477	21	3250@830	7160@120	3000@830	6610@120	75
245/75R22.5	G	000-280	95	7.50	37.4	9.6	17.6	10.6	555	19	2120@760	4675@110	1950@760	4300@110	75
265/75R22.5	G	000-281	97	7.50	38.4	10.2	18.0	11.1	541	21	2360@760	5205@110	2180@760	4805@110	75
295/75R22.5	G	241-592	118	8.25	40.3	11.4	18.8	12.5	515	21	2800@760	6175@110	2575@760	5675@110	75
295/75R22.5	H	002-920	118	8.25	40.3	11.4	18.8	12.5	515	21	3250@830	7160@120	3000@830	6610@120	75
295/80R22.5	H	000-282	138	8.25	41.6	11.7	19.4	12.7	499	21	3550@850	7830@123	3150@850	6940@123	75
285/75R24.5	G	248-749	125	8.25	41.5	11.3	19.5	12.4	501	21	2800@760	6175@110	2575@760	5675@110	75

\*Estimate, subject to change

- All dimensions taken with tire on measuring rim.
- Loaded dimensions and RPM measured at maximum dual load.
- For load and inflation tables see pages 91 through 96.
- For minimum dual spacing and approved rim widths see page 74.
- For ply ratings see table on page 72.
- Based on rolling resistance and field mileage tests, Bridgestone Ecopia and Bandag FuelTech are our most fuel-efficient and lowest total cost of ownership tire and retread solution. Combining proprietary low rolling resistance technology with the industry's most retreadable casing, Ecopia and FuelTech can help reduce fuel use and extend tire life for lower costs and greener returns, when compared to other Bridgestone tires.
- BASys® data from over two million Bridgestone, Goodyear and Michelin brand casings recorded between June 2009 and November 2010 prove that Bridgestone had the lowest percentage of tires that could not be retreaded due to conditions relating to casing construction.

Bridgestone tires and tubes are subject to an ongoing development program. Bridgestone Americas Tire Operations, LLC retains the right to amend specifications at any time without notice or obligations. Please refer to rim manufacturer's load and inflation limits. Never exceed rim manufacturer's limits without the consent of the component manufacturer.



**BRIDGESTONE**  
Your Journey, Our Passion

## R238 All-Position Tire

- Tread compound enhances resistance to tread scrubbing, leading to increased tread life.
- Sidewall protector ribs preserve casing durability by fighting curbing damage.
- Wide, Solid shoulder ribs help deliver enhanced resistance to maneuvering scrub and increased tread life.
- Wider belts extend to the shoulder area, which helps to reduce the occurrence of both irregular shoulder wear and casing damage.

### Recommended Application

An all-position tire specifically recommended for special service applications in:

**Regional Haul Service / Pickup & Delivery Service**

*Replaces:* Goodyear: G647, Endurance RSA  
Michelin: XZE

### TECHNICAL DATA

Tire Size	Load Range	Material Number	Weight (lbs.)	Meas. Rim	Overall Diam.	Overall Width	Static Loaded Radius	Overall Width (Loaded)	Revs Per Mile	Tread Depth (32')	Max. Tire Load (Single)		Max. Tire Load (Dual)		Max. Speed (MPH)
											Kg/kPa	Lbs/PSI	Kg/kPa	Lbs/PSI	
<b>R238</b>															
215/75R17.5	G	000-283	66	6.00	30.7	8.8	14.4	9.7	677	15	1700@690	3750@100	1600@690	3525@100	75
215/75R17.5	H	003-887	66	6.00	30.7	8.8	14.4	9.7	677	15	2180@860	4805@125	2060@860	4540@125	68
245/70R17.5	J	004-085	74	7.50	31.4	9.6	14.5	10.6	662	17	2725@860	6005@125	2575@860	5675@125	68
225/70R19.5	F	248-664	66	6.00	32.2	8.7	15.0	9.5	644	16	1650@660	3640@95	1550@660	3415@95	75
225/70R19.5	G	248-681	66	6.00	32.2	8.7	15.0	9.5	644	16	1800@760	3970@110	1700@760	3750@110	75
245/70R19.5	F	248-732	82	6.75	33.3	9.3	15.5	10.3	623	18	1850@660	4080@95	1750@660	3860@95	75
245/70R19.5	G	248-698	82	6.75	33.3	9.3	15.5	10.3	623	18	2060@760	4540@110	1950@760	4300@110	75
245/70R19.5	H	248-715	82	6.75	33.3	9.3	15.5	10.3	623	18	2240@830	4940@120	2120@830	4675@120	75
265/70R19.5	G	000-279	84	7.50	34.1	10.0	15.8	11.0	609	17	2500@760	5510@110	2360@760	5205@110	75

- All dimensions taken with tire on measuring rim.
- Loaded dimensions and RPM measured at maximum dual load.
- For load and inflation tables see pages 91 through 96.
- For minimum dual spacing and approved rim widths see page 74.
- For ply ratings see table on page 72.

Bridgestone tires and tubes are subject to an ongoing development program. Bridgestone Americas Tire Operations, LLC retains the right to amend specifications at any time without notice or obligations. Please refer to rim manufacturer's load and inflation limits. Never exceed rim manufacturer's limits without the consent of the component manufacturer.



**BRIDGESTONE**  
Your Journey, Our Passion

## R250 ED

All-Position Radial

- Extra-duty (ED) compound resists cuts and chips for enhanced performance in severe on-highway, moderate on/off-highway and mixed service applications.
- Five ribs with four wide, straight grooves for ideal handling and traction.
- Sidewall protector ribs fight damage from curbing, cuts and impacts.
- Cap/base compounding combines a slow-wearing cap compound with a cool-running base that shields the casing from damaging heat to enhance retreadability.

### Recommended Application

An all-position tire specifically recommended for steering applications in:

**High-Scrub Pickup & Delivery Service / Regional Haul Service  
Mixed and Moderate On/Off-Highway Service**

**Replaces:** Goodyear: G661, G662  
Michelin: XZE, XZE2, XZE2+

### TECHNICAL DATA

Tire Size	Load Range	Material Number	Weight (lbs.)	Meas. Rim	Overall Diam.	Overall Width	Static Loaded Radius	Overall Width (Loaded)	Revs Per Mile	Tread Depth (32')	Max. Tire Load (Single)		Max. Tire Load (Dual)		Max. Speed (MPH)
											Kg/kPa	Lbs/PSI	Kg/kPa	Lbs/PSI	
<b>R250 ED</b>															
11R22.5	H	206-973	117	8.25	41.4	10.9	19.3	12.0	501	19	3000@830	6610@120	2725@830	6005@120	75
11R24.5	H	206-990	125	8.25	43.5	10.9	20.3	11.9	478	19	3250@830	7160@120	3000@830	6610@120	75
255/70R22.5	H	216-568	95	8.25	36.7	10.3	17.2	11.4	567	18	2500@830	5510@120	2300@830	5070@120	75
275/70R22.5	J	216-585	110	8.25	38.0	10.7	17.6	11.8	547	19	3175@830	7000@120	2900@830	6395@120	75

- All dimensions taken with tire on measuring rim.
- Loaded dimensions and RPM measured at maximum dual load.
- For load and inflation tables see pages 91 through 96.
- For minimum dual spacing and approved rim widths see page 74.
- For ply ratings see table on page 72.

Bridgestone tires and tubes are subject to an ongoing development program. Bridgestone Americas Tire Operations, LLC retains the right to amend specifications at any time without notice or obligations. Please refer to rim manufacturer's load and inflation limits. Never exceed rim manufacturer's limits without the consent of the component manufacturer.



**BRIDGESTONE**  
Your Journey, Our Passion

## M710 Ecopia®

Fuel-Efficient Drive Radial



- Enhances fuel efficiency by combining a low rolling resistance tread and casing design with energy saving proprietary sidewall compounds.
- IntelliShape™ sidewalls reduce overall tire weight to improve fuel efficiency without sacrificing durability.
- Continuous shoulder and high rigidity tread pattern fight irregular wear for long tread life and low rolling resistance.

EPA SmartWay® verified  
and CARB compliant.

### Recommended Application

A drive tire recommended for tandem axle drive applications in:

**Long Haul Service / Regional Haul Service**

**Replaces:** Goodyear: G505D, G305

Michelin: XDA ENERGY, X Line Energy D

### TECHNICAL DATA

Tire Size	Load Range	Material Number	Weight (lbs.)	Meas. Rim	Overall Diam.	Overall Width	Static Loaded Radius	Overall Width (Loaded)	Revs Per Mile	Tread Depth (32")	Max. Tire Load (Single)		Max. Tire Load (Dual)		Max. Speed (MPH)
											Kg/kPa	Lbs/PSI	Kg/kPa	Lbs/PSI	
<b>M710 Ecopia</b>															
11R22.5	G	233-330	121	8.25	41.8	11.3	19.5	12.5	497	26	2800@720	6175@105	2650@720	5840@105	75
11R24.5	G	233-347	130	8.25	43.8	11.2	20.4	12.3	475	26	3000@720	6610@105	2725@720	6005@105	75
295/75R22.5	G	233-466	118	8.25	40.6	11.3	18.9	12.4	512	26	2800@760	6175@110	2575@760	5675@110	75
285/75R24.5	G	233-313	125	8.25	41.9	11.2	19.6	12.3	496	26	2800@760	6175@110	2575@760	5675@110	75

- Based on rolling resistance and field mileage tests, Bridgestone Ecopia and Bandag FuelTech are our most fuel-efficient and lowest total cost of ownership tire and retread solution. Combining proprietary low rolling resistance technology with the industry's most retreadable casing, Ecopia and FuelTech can help reduce fuel use and extend tire life for lower costs and greener returns, when compared to other Bridgestone tires.
- BASys® data from over two million Bridgestone, Goodyear and Michelin brand casings recorded between June 2009 and November 2010 prove that Bridgestone had the lowest percentage of tires that could not be retreaded due to conditions relating to casing construction.

- All dimensions taken with tire on measuring rim.
- Loaded dimensions and RPM measured at maximum dual load.
- For load and inflation tables see pages 91 through 96.
- For minimum dual spacing and approved rim widths see page 74.
- For ply ratings see table on page 72.

Bridgestone tires and tubes are subject to an ongoing development program. Bridgestone Americas Tire Operations, LLC retains the right to amend specifications at any time without notice or obligations. Please refer to rim manufacturer's load and inflation limits. Never exceed rim manufacturer's limits without the consent of the component manufacturer.



**BRIDGESTONE**  
Your Journey, Our Passion

## M760 Ecopia®

### Fuel-Efficient Drive Radial



- Narrow grooves help to combat the retention of casing-damaging stones and improve drilling resistance, leading to increased casing life and improved retreadability.
- IntelliShape™ sidewalls reduce overall tire weight to improve fuel efficiency without sacrificing durability.
- Extensive lug and shoulder siping to improve traction on wet and dry surfaces, and the extra-wide tread helps deliver added stability.
- Solid shoulder rib helps cut down on irregular wear by reducing tread squirm.

#### Recommended Application

A drive tire specifically recommended for high traction applications in:

**Long Haul Service / Regional Haul Service  
Pickup & Delivery Service**

**Replaces:** Goodyear: G572A  
Michelin: X Multi Energy D

EPA SmartWay® verified  
and CARB compliant.

#### TECHNICAL DATA

Tire Size	Load Range	Material Number	Weight (lbs.)	Meas. Rim	Overall Diam.	Overall Width	Static Loaded Radius	Overall Width (Loaded)	Revs Per Mile	Tread Depth (32')	Max. Tire Load (Single)		Max. Tire Load (Dual)		Max. Speed (MPH)
											Kg/kPa	Lbs/PSI	Kg/kPa	Lbs/PSI	
<b>M760 Ecopia</b>															
11R22.5	G	247-933	135	8.25	42.2	11.2	19.6	12.3	492	27	2800@720	6175@105	2650@720	5840@105	75
11R24.5	G	247-950	138	8.25	44.2	11.2	20.6	12.3	470	27	3000@720	6610@105	2725@720	6005@105	75
295/75R22.5	G	247-899	126	8.25	40.7	11.4	19.0	12.5	511	27	2800@760	6175@110	2575@760	5675@110	75
285/75R24.5	G	247-916	138	8.25	42.2	11.3	19.8	12.4	492	27	2800@760	6175@110	2575@760	5675@110	75

- Based on rolling resistance and field mileage tests, Bridgestone Ecopia and Bandag FuelTech are our most fuel-efficient and lowest total cost of ownership tire and retread solution. Combining proprietary low rolling resistance technology with the industry's most retreadable casing, Ecopia and FuelTech can help reduce fuel use and extend tire life for lower costs and greener returns, when compared to other Bridgestone tires.
- BASys® data from over two million Bridgestone, Goodyear and Michelin brand casings recorded between June 2009 and November 2010 prove that Bridgestone had the lowest percentage of tires that could not be retreaded due to conditions relating to casing construction.

- All dimensions taken with tire on measuring rim.
- Loaded dimensions and RPM measured at maximum dual load.
- For load and inflation tables see pages 91 through 96.
- For minimum dual spacing and approved rim widths see page 74.
- For ply ratings see table on page 72.

Bridgestone tires and tubes are subject to an ongoing development program. Bridgestone Americas Tire Operations, LLC retains the right to amend specifications at any time without notice or obligations. Please refer to rim manufacturer's load and inflation limits. Never exceed rim manufacturer's limits without the consent of the component manufacturer.



**BRIDGESTONE**  
Your Journey, Our Passion

## M726 ELA

### Drive Radial

- Testing shows the M726 ELA outperforms previous generation with 5% longer wear life and 12% lower rolling resistance
- Block sipes promote traction by slicing through water and high rigidity tread pattern offers long, even wear.
- Extra-deep tread depth provides maximum traction and maximum removal mileage.
- Rugged tread compound resists tread squirm and heel-toe wear for longer tread life.
- Continuous shoulder ribs distribute weight and torque evenly to fight irregular wear.
- Stone rejector platforms help prevent retention of damaging stones.

#### Recommended Application

A mega-deep drive tire recommended for drive applications in:

**Long Haul Service / Regional Haul Service  
Pickup & Delivery Service**

**Replaces:** Goodyear: G362, G622 RSD  
Michelin: XDA5, XDN2

#### TECHNICAL DATA

Tire Size	Load Range	Material Number	Weight (lbs.)	Meas. Rim	Overall Diam.	Overall Width	Static Loaded Radius	Overall Width (Loaded)	Revs Per Mile	Tread Depth (32')	Max. Tire Load (Single)		Max. Tire Load (Dual)		Max. Speed (MPH)
											Kg/kPa	Lbs/PSI	Kg/kPa	Lbs/PSI	
<b>M726 ELA</b>															
10R22.5	G	005-316	108	7.50	40.6	10.0	18.9	11.0	512	26	2575@790	5675@115	2430@790	5355@115	75
11R22.5	G	005-313	133	8.25	42.2	11.3	19.6	12.4	492	32	2800@720	6175@105	2650@720	5840@105	75
11R24.5	G	005-314	143	8.25	44.2	11.3	20.6	12.4	470	32	3000@720	6610@105	2725@720	6005@105	75
11R24.5	H	005-315	145	8.25	44.2	11.3	20.6	12.4	470	32	3250@830	7160@120	3000@830	6610@120	75
295/75R22.5	G	005-311	126	8.25	40.9	11.4	19.1	12.5	507	32	2800@760	6175@110	2575@760	5675@110	75
285/75R24.5	G	005-312	135	8.25	42.2	11.3	19.8	12.4	492	32	2800@760	6175@110	2575@760	5675@110	75

- All dimensions taken with tire on measuring rim.
- Loaded dimensions and RPM measured at maximum dual load.
- For load and inflation tables see pages 91 through 96.
- For minimum dual spacing and approved rim widths see page 74.
- For ply ratings see table on page 72.

Bridgestone tires and tubes are subject to an ongoing development program. Bridgestone Americas Tire Operations, LLC retains the right to amend specifications at any time without notice or obligations. Please refer to rim manufacturer's load and inflation limits. Never exceed rim manufacturer's limits without the consent of the component manufacturer.



**BRIDGESTONE**  
Your Journey, Our Passion

## M726 Drive Radial

- 26/32" tread depth helps to provide long original life and the aggressive tread pattern design helps to provide sure traction.
- Continuous shoulder ribs distribute weight and torque evenly to fight irregular wear.
- Center groove platforms help reject damaging stones to enhance casing durability.

### Recommended Application

Recommended for drive applications in:  
**Long Haul Service / Regional Haul Service**  
**Pickup & Delivery Service**

*Replaces:* Goodyear: G622  
Michelin: XD2

### TECHNICAL DATA

Tire Size	Load Range	Material Number	Weight (lbs.)	Meas. Rim	Overall Diam.	Overall Width	Static Loaded Radius	Overall Width (Loaded)	Revs Per Mile	Tread Depth (32')	Max. Tire Load (Single)		Max. Tire Load (Dual)		Max. Speed (MPH)
											Kg/kPa	Lbs/PSI	Kg/kPa	Lbs/PSI	
<b>M726</b>															
255/70R22.5	H	297-585	102	8.25	37.3	10.3	17.4	11.2	557	26	2500@830	5510@120	2300@830	5070@120	75

- All dimensions taken with tire on measuring rim.
- Loaded dimensions and RPM measured at maximum dual load.
- For load and inflation tables see pages 91 through 96.
- For minimum dual spacing and approved rim widths see page 74.
- For ply ratings see table on page 72.

Bridgestone tires and tubes are subject to an ongoing development program. Bridgestone Americas Tire Operations, LLC retains the right to amend specifications at any time without notice or obligations. Please refer to rim manufacturer's load and inflation limits. Never exceed rim manufacturer's limits without the consent of the component manufacturer.







**BRIDGESTONE**  
Your Journey, Our Passion

## M749 Drive Radial

- Patented WavedBelt™ design preserves casing durability by minimizing stress at the belt edges to maintain a stable footprint and reduce casing growth.
- Tie bars control movement of the shoulder tread block for lower rolling resistance and long, even wear.
- The directional, open shoulder tread pattern provides reliable wet traction throughout the original tread life of the tire.
- Cut and chip resistant compounding fights damage from curbing, cuts, and abrasions.
- Multiple cross-rib sipes improve traction by slicing through water for a solid grip on wet roads.
- Flexible groove fence partitions in the tire groove dampen the noise produced by air bumping for a quieter ride.

### Recommended Application

Designed primarily for auto haulers.  
Recommended in:

**Auto Haulers / Long Haul Service / Regional Haul Service**

*Replaces:* Michelin: X MultiWay XD

### TECHNICAL DATA

Tire Size	Load Range	Material Number	Weight (lbs.)	Meas. Rim	Overall Diam.	Overall Width	Static Loaded Radius	Overall Width (Loaded)	Revs Per Mile	Tread Depth (32")	Max. Tire Load (Single)		Max. Tire Load (Dual)		Max. Speed (MPH)
											Kg/kPa	Lbs/PSI	Kg/kPa	Lbs/PSI	
<b>M749</b>															
295/60R22.5	J	224-966	127	9.00	36.8	11.8	17.3	12.9	568	22	3350@900	7390@130	3075@900	6780@130	75

- All dimensions taken with tire on measuring rim.
- Loaded dimensions and RPM measured at maximum dual load.
- For load and inflation tables see pages 91 through 96.
- For minimum dual spacing and approved rim widths see page 74.
- For ply ratings see table on page 72.

Bridgestone tires and tubes are subject to an ongoing development program. Bridgestone Americas Tire Operations, LLC retains the right to amend specifications at any time without notice or obligations. Please refer to rim manufacturer's load and inflation limits. Never exceed rim manufacturer's limits without the consent of the component manufacturer.



**BRIDGESTONE**  
Your Journey, Our Passion



**Greatec®  
M835A Ecopia®**  
Fuel-Efficient  
Wide Base Radial

- Testing results show improvements should delivers up to 20% longer removal miles than previous generation
- Exclusive WavedBelt™ casing enhances durability, irregular wear resistance, tread life and penetration protection.
- High rigidity tread pattern with patented NanoPro-Tech® compound, along with energy-saving sidewalls lower rolling resistance for optimum fuel efficiency.
- Continuous shoulder design fights irregular wear while stone rejector platforms and exclusive Turn In Ply™ bead enhance retreadability.

EPA SmartWay® verified  
and CARB compliant.

**Recommended Application**

A wide base drive tire recommended for tandem-axle drive applications in:  
**Long Haul Service**

**Replaces:** Goodyear: G392 SSD  
Michelin: X One Line Energy D

**TECHNICAL DATA**

Tire Size	Load Range	Material Number	Weight (lbs.)	Meas. Rim	Overall Diam.	Overall Width	Static Loaded Radius	Overall Width (Loaded)	Revs Per Mile	Tread Depth (32')	Max. Tire Load (Single)		Max. Tire Load (Dual)		Max. Speed (MPH)
											Kg/kPa	Lbs/PSI	Kg/kPa	Lbs/PSI	
<b>Greatec M835A Ecopia</b>															
445/50R22.5	L	241-609	173	14.00	39.9	17.7	18.6	19.4	524	23	4625@830	10,200@120	-	-	75

- Based on rolling resistance and field mileage tests, Bridgestone Ecopia and Bandag FuelTech are our most fuel-efficient and lowest total cost of ownership tire and retread solution. Combining proprietary low rolling resistance technology with the industry's most retreadable casing, Ecopia and FuelTech can help reduce fuel use and extend tire life for lower costs and greener returns, when compared to other Bridgestone tires.
- BASys® data from over two million Bridgestone, Goodyear and Michelin brand casings recorded between June 2009 and November 2010 prove that Bridgestone had the lowest percentage of tires that could not be retreaded due to conditions relating to casing construction.

- All dimensions taken with tire on measuring rim.
- Loaded dimensions and RPM measured at maximum dual load.
- For load and inflation tables see pages 91 through 96.
- For minimum dual spacing and approved rim widths see page 74.
- For ply ratings see table on page 72.

Bridgestone tires and tubes are subject to an ongoing development program. Bridgestone Americas Tire Operations, LLC retains the right to amend specifications at any time without notice or obligations. Please refer to rim manufacturer's load and inflation limits. Never exceed rim manufacturer's limits without the consent of the component manufacturer.



**BRIDGESTONE**  
Your Journey, Our Passion

## M770 Drive Radial

- A wide and deep open-shoulder tread pattern helps to provide long original tread life and high removal miles.
- Larger shoulder groove radius, together with innovative groove and block shapes fight lug base cracking and tearing for long life.
- Irregular wear-fighting sipeless block design promotes even wear while combating sipe erosion and tearing.
- Retreadability enhanced by cool-running cap/base tread construction and stone rejector platforms in all grooves.

### Recommended Application

Recommended for single drive axle applications such as 4X2 and 6X2 tractors, and 4X2 straight trucks in:

**Long Haul Service / Regional Haul Service  
Pickup & Delivery Service**

**Replaces:** Goodyear: G338  
Michelin: XD4, XDN2, XDE M/S

### TECHNICAL DATA

Tire Size	Load Range	Material Number	Weight (lbs.)	Meas. Rim	Overall Diam.	Overall Width	Static Loaded Radius	Overall Width (Loaded)	Revs Per Mile	Tread Depth (32")	Max. Tire Load (Single)		Max. Tire Load (Dual)		Max. Speed (MPH)
											Kg/kPa	Lbs/PSI	Kg/kPa	Lbs/PSI	
<b>M770</b>															
11R22.5	G	187-644	130	8.25	42.2	10.8	19.6	11.9	492	31	2800@720	6175@105	2650@720	5840@105	75
11R22.5	H	211-104	130	8.25	42.2	10.8	19.6	11.9	492	31	3000@830	6610@120	2725@830	6005@120	75
11R24.5	G	187-695	140	8.25	44.2	10.7	20.6	11.8	470	31	3000@720	6610@105	2725@720	6005@105	75
295/75R22.5	G	233-364	129	8.25	41.0	11.4	19.2	12.5	506	31	2800@760	6175@110	2575@760	5675@110	75
285/75R24.5	G	187-610	135	8.25	42.2	11.3	19.8	12.5	492	31	2800@760	6175@110	2575@760	5675@110	75

- All dimensions taken with tire on measuring rim.
- Loaded dimensions and RPM measured at maximum dual load.
- For load and inflation tables see pages 91 through 96.
- For minimum dual spacing and approved rim widths see page 74.
- For ply ratings see table on page 72.

Bridgestone tires and tubes are subject to an ongoing development program. Bridgestone Americas Tire Operations, LLC retains the right to amend specifications at any time without notice or obligations. Please refer to rim manufacturer's load and inflation limits. Never exceed rim manufacturer's limits without the consent of the component manufacturer.



**BRIDGESTONE**  
Your Journey, Our Passion

## M799 Drive Radial

- Aggressive, open-shoulder design helps deliver long tread life and traction.
- Tough tread compound with stone rejector platforms in center grooves provide long life and outstanding retreadability.
- Sidewall protector ribs help shield casing against worksite cut, impact and abrasion damage for durability and retreadability.
- Extensive block siping improves traction by slicing through water for a solid grip on wet roads.

### Recommended Application

A drive tire specifically recommended for high traction and high scrub applications in:  
**Light On/Off-Highway Service / Regional Haul Service  
Pickup & Delivery Service**

*Replaces:* Goodyear: G182  
Michelin: XDE M/S

### TECHNICAL DATA

Tire Size	Load Range	Material Number	Weight (lbs.)	Meas. Rim	Overall Diam.	Overall Width	Static Loaded Radius	Overall Width (Loaded)	Revs Per Mile	Tread Depth (32")	Max. Tire Load (Single)		Max. Tire Load (Dual)		Max. Speed (MPH)
											Kg/kPa	Lbs/PSI	Kg/kPa	Lbs/PSI	
<b>M799</b>															
11R22.5	H	245-434	124	8.25	42.0	11.2	19.5	12.3	495	28	3000@830	6610@120	2725@830	6005@120	75
11R24.5	H	233-585	139	8.25	44.0	11.2	20.5	12.3	472	28	3250@830	7160@120	3000@830	6610@120	75
12R22.5	H	233-602	150	9.00	43.3	11.7	20.1	12.8	479	30	3350@830	7390@120	3075@830	6780@120	75

- All dimensions taken with tire on measuring rim.
- Loaded dimensions and RPM measured at maximum dual load.
- For load and inflation tables see pages 91 through 96.
- For minimum dual spacing and approved rim widths see page 74.
- For ply ratings see table on page 72.

Bridgestone tires and tubes are subject to an ongoing development program. Bridgestone Americas Tire Operations, LLC retains the right to amend specifications at any time without notice or obligations. Please refer to rim manufacturer's load and inflation limits. Never exceed rim manufacturer's limits without the consent of the component manufacturer.



**BRIDGESTONE**  
Your Journey, Our Passion

## M729F

### Drive Radial

- Aggressive pattern improves traction in all weather conditions.
- Casing construction and cap/base compounding improve durability and retreadability.
- Sidewall protector ribs resist cuts and abrasions from curbing and impacts.

#### Recommended Application

A drive tire recommended for high traction and high scrub applications in:

**Long Haul Service / Regional Haul Service  
Pickup & Delivery Service**

**Replaces:** Goodyear: G622  
Michelin: XDE2+, XDS2

#### TECHNICAL DATA

Tire Size	Load Range	Material Number	Weight (lbs.)	Meas. Rim	Overall Diam.	Overall Width	Static Loaded Radius	Overall Width (Loaded)	Revs Per Mile	Tread Depth (32')	Max. Tire Load (Single)		Max. Tire Load (Dual)		Max. Speed (MPH)
											Kg/kPa	Lbs/PSI	Kg/kPa	Lbs/PSI	
<b>M729F</b>															
215/75R17.5	F	160-427	60	6.00	30.7	8.5	14.4	9.3	668	22	1700@690	3750@100	1600@690	3525@100	75
225/70R19.5	F	299-839	67	6.00	32.5	8.5	15.3	9.4	639	19	1650@660	3640@95	1550@660	3415@95	75
225/70R19.5	G	227-023	67	6.00	32.5	8.5	15.1	9.4	639	19	1800@760	3970@110	1700@760	3750@110	75
245/70R19.5	H	227-040	75	7.50	33.4	9.5	15.5	10.5	622	19	2240@830	4940@120	2120@830	4675@120	75
265/70R19.5	G	152-498	88	7.50	34.4	9.9	15.9	10.8	604	19	2500@760	5510@110	2360@760	5205@110	75
285/70R19.5	H	158-914	98	8.25	35.4	10.6	16.3	11.6	587	20	2900@860	6395@125	2725@860	6005@125	75

- All dimensions taken with tire on measuring rim.
- Loaded dimensions and RPM measured at maximum dual load.
- For load and inflation tables see pages 91 through 96.
- For minimum dual spacing and approved rim widths see page 74.
- For ply ratings see table on page 72.

Bridgestone tires and tubes are subject to an ongoing development program. Bridgestone Americas Tire Operations, LLC retains the right to amend specifications at any time without notice or obligations. Please refer to rim manufacturer's load and inflation limits. Never exceed rim manufacturer's limits without the consent of the component manufacturer.



**BRIDGESTONE**  
Your Journey, Our Passion

## M895

### Metro All-Position Radial

- Suitable for both steer and drive axle positions on delivery vehicles, vans and moving trucks.
- Sure handling to help reduce noise and wander, even on highways with rain grooves.
- Stabilizing continuous shoulder design combats irregular wear for long original tread life.
- Groove bottom platforms to fight retention of casing-damaging stones.
- Stone rejector platforms help prevent retention of casing-damaging stones.

#### Recommended Application

An all-position tire recommended for steering and drive applications in:

**Pickup & Delivery Service**

*Replaces:* Goodyear: G622  
Michelin: XDS2

#### TECHNICAL DATA

Tire Size	Load Range	Material Number	Weight (lbs.)	Meas. Rim	Overall Diam.	Overall Width	Static Loaded Radius	Overall Width (Loaded)	Revs Per Mile	Tread Depth (32')	Max. Tire Load (Single)		Max. Tire Load (Dual)		Max. Speed (MPH)
											Kg/kPa	Lbs/PSI	Kg/kPa	Lbs/PSI	
<b>M895</b>															
245/70R19.5	G	227-006	74	6.75	33.3	9.1	15.4	10.0	624	17	2060@760	4540@110	1950@760	4300@110	75

- All dimensions taken with tire on measuring rim.
- Loaded dimensions and RPM measured at maximum dual load.
- For load and inflation tables see pages 91 through 96.
- For minimum dual spacing and approved rim widths see page 74.
- For ply ratings see table on page 72.

Bridgestone tires and tubes are subject to an ongoing development program. Bridgestone Americas Tire Operations, LLC retains the right to amend specifications at any time without notice or obligations. Please refer to rim manufacturer's load and inflation limits. Never exceed rim manufacturer's limits without the consent of the component manufacturer.



**BRIDGESTONE**  
Your Journey, Our Passion

## M724F

### Metro All-Position Radial

- Suitable for both steer and drive axle positions for delivery vehicles, vans and moving trucks.
- Extensive lug and shoulder sipes cut through water film to fight hydroplaning.
- Aggressive tread pattern for a firm grip in rain, mud and snow.
- Sidewall protector ribs resist curb damage and abrasion.

#### Recommended Application

An all-position tire recommended for steering and drive applications in:  
**Long Haul Service / Regional Haul Service**  
**Pickup & Delivery Service**

**Replaces:** Goodyear: G622, G633  
 Michelin: XDS2, XDE2+

245/70R19.5 pictured above

#### TECHNICAL DATA

Tire Size	Load Range	Material Number	Weight (lbs.)	Meas. Rim	Overall Diam.	Overall Width	Static Loaded Radius	Overall Width (Loaded)	Revs Per Mile	Tread Depth (32')	Max. Tire Load (Single)		Max. Tire Load (Dual)		Max. Speed (MPH)
											Kg/kPa	Lbs/PSI	Kg/kPa	Lbs/PSI	
<b>M724F</b>															
225/70R19.5	F	272-876	67	6.75	32.6	8.7	15.3	9.6	637	20	1650@660	3640@95	1550@660	3415@95	75
245/70R19.5	H	001-712	79	7.50	33.5	9.7	15.6	10.4	620	21	2240@760	4940@120	2120@760	4675@120	75

- All dimensions taken with tire on measuring rim.
- Loaded dimensions and RPM measured at maximum dual load.
- For load and inflation tables see pages 91 through 96.
- For minimum dual spacing and approved rim widths see page 74.
- For ply ratings see table on page 72.

Bridgestone tires and tubes are subject to an ongoing development program. Bridgestone Americas Tire Operations, LLC retains the right to amend specifications at any time without notice or obligations. Please refer to rim manufacturer's load and inflation limits. Never exceed rim manufacturer's limits without the consent of the component manufacturer.





**BRIDGESTONE**  
Your Journey, Our Passion

## R197 Ecopia® All-Position Radial



- Optimized fuel efficiency by combining a low rolling resistance tread and casing design with energy saving proprietary sidewall compounds.
- IntelliShape™ sidewalls reduce overall tire weight to improve fuel efficiency without sacrificing durability.
- Defense Groove™ design combats irregular wear while sidewall protector ribs fight curbing, cut and abrasion damage.

EPA SmartWay® verified  
and CARB compliant.

### Recommended Application

An all-position tire recommended for single- and tandem-axle trailer and dolly applications in:

**Long Haul Service / Regional Haul Service**

*Replaces:* Goodyear: G316 LHT, LHT  
Michelin: X Line Energy T

### TECHNICAL DATA

Tire Size	Load Range	Material Number	Weight* (lbs.)	Meas. Rim	Overall Diam.	Overall Width	Static Loaded Radius	Overall Width (Loaded)	Revs Per Mile	Tread Depth (32')	Max. Tire Load (Single)		Max. Tire Load (Dual)		Max. Speed (MPH)
											Kg/kPa	Lbs/PSI	Kg/kPa	Lbs/PSI	
<b>R197 Ecopia®</b>															
11R22.5	G	238-855	108	8.25	40.7	11.3	19.0	12.5	510	11	2800@720	6175@105	2650@720	5840@105	75
11R24.5	G	238-872	116	8.25	42.8	11.4	20.0	12.5	486	11	3000@720	6610@105	2725@720	6005@105	75
255/70R22.5	H	000-323	88	8.25	36.3	10.4	16.9	11.5	572	11	2500@830	5510@120	2300@830	5070@120	75
295/75R22.5	G	238-804	101	8.25	39.7	11.3	18.5	12.5	524	11	2800@760	6175@110	2575@760	5675@110	75
285/75R24.5	G	238-838	107	8.25	41.0	11.3	19.3	12.4	507	11	2800@760	6175@110	2575@760	5675@110	75

\*Estimate, subject to change

- All dimensions taken with tire on measuring rim.
- Loaded dimensions and RPM measured at maximum dual load.
- For load and inflation tables see pages 91 through 96.
- For minimum dual spacing and approved rim widths see page 74.
- For ply ratings see table on page 72.

- Based on rolling resistance and field mileage tests, Bridgestone Ecopia and Bandag FuelTech are our most fuel-efficient and lowest total cost of ownership tire and retread solution. Combining proprietary low rolling resistance technology with the industry's most retreadable casing, Ecopia and FuelTech can help reduce fuel use and extend tire life for lower costs and greener returns, when compared to other Bridgestone tires.
- BASys® data from over two million Bridgestone, Goodyear and Michelin brand casings recorded between June 2009 and November 2010 prove that Bridgestone had the lowest percentage of tires that could not be retreaded due to conditions relating to casing construction.

Bridgestone tires and tubes are subject to an ongoing development program. Bridgestone Americas Tire Operations, LLC retains the right to amend specifications at any time without notice or obligations. Please refer to rim manufacturer's load and inflation limits. Never exceed rim manufacturer's limits without the consent of the component manufacturer.



**BRIDGESTONE**  
Your Journey, Our Passion

## R196

### All-Position High-Scrub Radial

- Deep tread depth for high-scrub trailer service.
- Wide, continuous shoulder ribs fight turning side forces and resist tearing.
- Belt package protects against side forces encountered on spread and multi-axle trailers.
- Tough tread compounds fight scrub wear, yet run cool for long mileage.

#### Recommended Application

Recommended for spread-axle trailer applications in:  
**Long Haul Service / Regional Haul Service**  
**Pickup & Delivery Service**

*Replaces:* Goodyear: G619, G661  
Michelin: XTE

#### TECHNICAL DATA

Tire Size	Load Range	Material Number	Weight (lbs.)	Meas. Rim	Overall Diam.	Overall Width	Static Loaded Radius	Overall Width (Loaded)	Revs Per Mile	Tread Depth (32')	Max. Tire Load (Single)		Max. Tire Load (Dual)		Max. Speed (MPH)
											Kg/kPa	Lbs/PSI	Kg/kPa	Lbs/PSI	
<b>R196</b>															
11R22.5	G	290-920	111	8.25	41.3	10.8	19.3	11.9	503	16	2800@720	6175@105	2650@720	5840@105	75
11R24.5	G	290-939	120	8.25	43.3	10.7	20.3	11.8	480	16	3000@720	6610@105	2725@720	6005@105	75
295/75R22.5	G	296-325	111	8.25	40.0	10.8	18.7	11.9	519	16	2800@760	6175@110	2575@760	5675@110	75
285/75R24.5	G	296-333	116	8.25	41.5	10.7	19.5	11.8	501	16	2800@760	6175@110	2575@760	5675@110	75

- All dimensions taken with tire on measuring rim.
- Loaded dimensions and RPM measured at maximum dual load.
- For load and inflation tables see pages 91 through 96.
- For minimum dual spacing and approved rim widths see page 74.
- For ply ratings see table on page 72.

Bridgestone tires and tubes are subject to an ongoing development program. Bridgestone Americas Tire Operations, LLC retains the right to amend specifications at any time without notice or obligations. Please refer to rim manufacturer's load and inflation limits. Never exceed rim manufacturer's limits without the consent of the component manufacturer.





**BRIDGESTONE**  
Your Journey, Our Passion

**Greatec®  
R197 Ecopia®**  
Fuel-Efficient Wide Base  
Trailer Radial



- Testing results show 6% better rolling resistance and up to 20% longer removal miles than the previous generation (Greatec R135).
- Exclusive WavedBelt™ casing enhances durability, irregular wear resistance, tread life and penetration protection.
- High rigidity tread pattern with patented NanoPro-Tech® compound, along with energy-saving sidewalls lower rolling resistance for optimum fuel efficiency.
- Equalizer Rib™ and Defense Groove™ features promote long, even wear, while sidewall protector ribs fight curbing, cut and abrasion damage.

EPA SmartWay® verified  
and CARB compliant.

**Recommended Application**

A wide base trailer tire recommended for tandem axle trailer applications in:

**Long Haul Service**

**Replaces:** Goodyear: G394 SST

Michelin: X One Line Energy T

**TECHNICAL DATA**

Tire Size	Load Range	Material Number	Weight (lbs.)	Meas. Rim	Overall Diam.	Overall Width	Static Loaded Radius	Overall Width (Loaded)	Revs Per Mile	Tread Depth (32")	Max. Tire Load (Single)		Max. Tire Load (Dual)		Max. Speed (MPH)
											Kg/kPa	Lbs/PSI	Kg/kPa	Lbs/PSI	
<b>Greatec® R197 Ecopia®</b>															
445/50R22.5	L	006-713	152	14.00	39.2	19.4	18.3	19.4	533	11	4625@830	10,200@120	-	-	75

- Based on rolling resistance and field mileage tests, Bridgestone Ecopia and Bandag FuelTech are our most fuel-efficient and lowest total cost of ownership tire and retread solution. Combining proprietary low rolling resistance technology with the industry's most retreadable casing, Ecopia and FuelTech can help reduce fuel use and extend tire life for lower costs and greener returns, when compared to other Bridgestone tires.
- BASys® data from over two million Bridgestone, Goodyear and Michelin brand casings recorded between June 2009 and November 2010 prove that Bridgestone had the lowest percentage of tires that could not be retreaded due to conditions relating to casing construction.

- All dimensions taken with tire on measuring rim.
- Loaded dimensions and RPM measured at maximum dual load.
- For load and inflation tables see pages 91 through 96.
- For minimum dual spacing and approved rim widths see page 74.
- For ply ratings see table on page 72.

Bridgestone tires and tubes are subject to an ongoing development program. Bridgestone Americas Tire Operations, LLC retains the right to amend specifications at any time without notice or obligations. Please refer to rim manufacturer's load and inflation limits. Never exceed rim manufacturer's limits without the consent of the component manufacturer.



**BRIDGESTONE**  
Your Journey, Our Passion

## R180

*All-Position Radial*

- Five-rib tread pattern for even load distribution in any axle position.
- Multiple cross-rib sipes cut through water for a solid grip on wet roads.
- Four wide grooves to channel water out of footprint for superb traction.

### Recommended Application

An all-position tire recommended for general use in:  
**Pickup & Delivery Service**

*Replaces:* Goodyear: G114  
Michelin: XZA

### TECHNICAL DATA

Tire Size	Load Range	Material Number	Weight (lbs.)	Meas. Rim	Overall Diam.	Overall Width	Static Loaded Radius	Overall Width (Loaded)	Revs Per Mile	Tread Depth (32')	Max. Tire Load (Single)		Max. Tire Load (Dual)		Max. Speed (MPH)
											Kg/kPa	Lbs/PSI	Kg/kPa	Lbs/PSI	
<b>R180</b>															
9R17.5	G	272-914	64	6.75	33.1	9.1	15.4	10.0	628	14	1850@830	4080@120	1750@830	3860@120	75

- All dimensions taken with tire on measuring rim.
- Loaded dimensions and RPM measured at maximum dual load.
- For load and inflation tables see pages 91 through 96.
- For minimum dual spacing and approved rim widths see page 74.
- For ply ratings see table on page 72.



**BRIDGESTONE**  
Your Journey, Our Passion

## Greatec® M845

Wide Base All-Position Radial

- Proprietary next-generation WavedBelt™ design improves irregular wear performance, especially at the shoulder area, by keeping the crown shape throughout the tire's life. This advancement enhances durability and also lowers rolling resistance by reducing deformation around the belt area.
- Exclusive Turn In Ply™ bead and stone rejector platforms combine to enhance retreadability.
- Aggressive wide- and deep-tread pattern delivers solid traction, and long life.
- Long-wearing scrub-resistant tread compound delivers high removal mileage for urban/regional use.

### Recommended Application

A wide-base tire recommended for drive and trailer positions for high-traction and high-scrub applications in:

**Urban/Regional Service**

**Replaces:** Michelin: X One XZUS

### TECHNICAL DATA

Tire Size	Load Range	Material Number	Weight* (lbs.)	Meas. Rim	Overall Diam.	Overall Width	Static Loaded Radius	Overall Width (Loaded)	Revs Per Mile	Tread Depth (32')	Max. Tire Load (Single)		Max. Tire Load (Dual)		Max. Speed (MPH)
											Kg/kPa	Lbs/PSI	Kg/kPa	Lbs/PSI	
<b>Greatec® M845</b>															
455/55R22.5	M	241-422	218	14.00	41.9	18.1	19.4	19.9	496	23	5300@900	11700@130	-	-	75

\*Estimate, subject to change

- All dimensions taken with tire on measuring rim.
- Loaded dimensions and RPM measured at maximum dual load.
- For load and inflation tables see pages 91 through 96.
- For minimum dual spacing and approved rim widths see page 74.
- For ply ratings see table on page 72.

Bridgestone tires and tubes are subject to an ongoing development program. Bridgestone Americas Tire Operations, LLC retains the right to amend specifications at any time without notice or obligations. Please refer to rim manufacturer's load and inflation limits. Never exceed rim manufacturer's limits without the consent of the component manufacturer.



**BRIDGESTONE**  
Your Journey, Our Passion

## Greatec® M853

On/Off-Highway  
Wide Base Radial

- Optimized WavedBelt™ enhances casing durability and wearout performance by maintaining a stable footprint and reducing casing growth throughout tire life.
- Exclusive Turn In Ply™ bead and stone rejector platforms combine to enhance retreadability.
- Extra-wide- and -deep tread pattern delivers solid traction, long life and excellent handling.
- Long-wearing special tread compound helps prevent tread damage for high removal mileage.
- Continuous shoulder offers long, even wear and reduces rolling resistance by controlling movement of the ribs and blocks during rotation.

### Recommended Application

A wide-base tire recommended for drive and trailer positions in on/off-highway service.

### Severe Service

**Replaces:** Michelin: X One XZUS

### TECHNICAL DATA

Tire Size	Load Range	Material Number	Weight* (lbs.)	Meas. Rim	Overall Diam.	Overall Width	Static Loaded Radius	Overall Width (Loaded)	Revs Per Mile	Tread Depth (32")	Max. Tire Load (Single)		Max. Tire Load (Dual)		Max. Speed (MPH)
											Kg/kPa	Lbs/PSI	Kg/kPa	Lbs/PSI	
<b>Greatec® M845</b>															
455/55R22.5	M	241-422	215	14.00	41.9	18.1	19.4	20	496	23	5300@900	11700@130	-	-	75

\*Estimate, subject to change

- All dimensions taken with tire on measuring rim.
- Loaded dimensions and RPM measured at maximum dual load.
- For load and inflation tables see pages 91 through 96.
- For minimum dual spacing and approved rim widths see page 74.
- For ply ratings see table on page 72.

Bridgestone tires and tubes are subject to an ongoing development program. Bridgestone Americas Tire Operations, LLC retains the right to amend specifications at any time without notice or obligations. Please refer to rim manufacturer's load and inflation limits. Never exceed rim manufacturer's limits without the consent of the component manufacturer.



**BRIDGESTONE**  
Your Journey, Our Passion

## M860A

### High Scrub All-Position Radial

- Specifically designed and compounded for refuse hauling and other high scrub, short haul applications.
- Deep tread depth and optimized tread width for increased mileage.
- Casing durability is enhanced through sidewall protector ribs designed to fight curbing and abrasion damage, and through center groove stone rejectors to combat stone retention damage.
- 65-MPH speed rating allows higher sustained speed for on-highway driving.
- Special cap compound (M860A) offers improved wear performance, leading to longer original tread life.

#### Recommended Application

An all-position tire recommended for steering positions in refuse, high scrub, short haul applications.

**Replaces:** Goodyear: G287, G289  
Michelin: XZUS2, XZUS, XZY3

#### TECHNICAL DATA

Tire Size	Load Range	Material Number	Weight (lbs.)	Meas. Rim	Overall Diam.	Overall Width	Static Loaded Radius	Overall Width (Loaded)	Revs Per Mile	Tread Depth (32')	Max. Tire Load (Single)		Max. Tire Load (Dual)		Max. Speed (MPH)
											Kg/kPa	Lbs/PSI	Kg/kPa	Lbs/PSI	
<b>M860A</b>															
315/80R22.5	L	244-329	161	9.00	42.8	12.6	19.9	13.9	485	24	4540@900	10000@130	4120@900	9090@130	65
425/65R22.5	L	001-741	192	12.25	44.9	16.1	20.8	17.8	463	23	5150@830	11400@120	—	—	65

- All dimensions taken with tire on measuring rim.
- Loaded dimensions and RPM measured at maximum dual load.
- For load and inflation tables see pages 91 through 96.
- For minimum dual spacing and approved rim widths see page 74.
- For ply ratings see table on page 72.

Bridgestone tires and tubes are subject to an ongoing development program. Bridgestone Americas Tire Operations, LLC retains the right to amend specifications at any time without notice or obligations. Please refer to rim manufacturer's load and inflation limits. Never exceed rim manufacturer's limits without the consent of the component manufacturer.





**BRIDGESTONE**  
Your Journey, Our Passion

## M853

*On/Off-Highway  
All-Position Radial*

- Cap/base compounding combines a slow-wearing cap compound with a cool-running base that shields the casing from damaging heat to enhance retreadability.
- Special on/off-highway tread compound with resistance to cuts, chips, tears and irregular wear for high removal mileage.
- Stone rejector platforms and optimized groove wall angles to combat retention of damaging stones for excellent retreadability.
- Sidewall protector ribs shield casing against worksite cut, impact and abrasion damage for durability and retreadability.

### Recommended Application

An all-position tire recommended for steer, drive and trailer positions in on/off-highway service.

**Replaces:** Goodyear: G287, G289  
Michelin: XZY3

### TECHNICAL DATA

Tire Size	Load Range	Material Number	Weight (lbs.)	Meas. Rim	Overall Diam.	Overall Width	Static Loaded Radius	Overall Width (Loaded)	Revs Per Mile	Tread Depth (32")	Max. Tire Load (Single)		Max. Tire Load (Dual)		Max. Speed (MPH)
											Kg/kPa	Lbs/PSI	Kg/kPa	Lbs/PSI	
<b>M853</b>															
11R22.5	H	225-000	138	8.25	41.8	11.2	19.4	12.3	497	25	3000@830	6610@120	2725@830	6005@120	65
12R22.5	H	225-051	149	9.00	43.2	11.7	20.0	12.8	481	25	3350@830	7390@120	3075@830	6780@120	65
11R24.5	H	225-034	147	8.25	43.9	11.2	20.5	12.3	474	25	3250@830	7160@120	3000@830	6610@120	65

- All dimensions taken with tire on measuring rim.
- Loaded dimensions and RPM measured at maximum dual load.
- For load and inflation tables see pages 91 through 96.
- For minimum dual spacing and approved rim widths see page 74.
- For ply ratings see table on page 72.

Bridgestone tires and tubes are subject to an ongoing development program. Bridgestone Americas Tire Operations, LLC retains the right to amend specifications at any time without notice or obligations. Please refer to rim manufacturer's load and inflation limits. Never exceed rim manufacturer's limits without the consent of the component manufacturer.



**BRIDGESTONE**  
Your Journey, Our Passion

## M843

On/Off-Highway  
All-Position Radial

- Extra-deep tread for aggressive traction and long original mileage.
- Special tread compounds for resistance to cuts, chips, tearing and irregular wear.
- Self-cleaning tread for high traction; center groove platforms with stone rejectors for enhanced durability.
- Split-belt construction for resistance to road hazards, leading to better casing durability.

### Recommended Application

An all-position tire recommended for drive and trailer positions in on/off-highway service.

**Replaces:** Goodyear: G287, G288  
Michelin: XDS, XDS2

### TECHNICAL DATA

Tire Size	Load Range	Material Number	Weight* (lbs.)	Meas. Rim	Overall Diam.	Overall Width	Static Loaded Radius	Overall Width (Loaded)	Revs Per Mile	Tread Depth (32")	Max. Tire Load (Single)		Max. Tire Load (Dual)		Max. Speed (MPH)
											Kg/kPa	Lbs/PSI	Kg/kPa	Lbs/PSI	
<b>M843</b>															
11R22.5	G	287-849	139	8.25	42.5	11.1	19.9	12.2	489	26	2800@720	6175@105	2650@720	5840@105	65
11R22.5	H	287-857	139	8.25	42.5	11.1	19.9	12.2	489	26	3000@830	6610@120	2725@830	6005@120	65
12R22.5	H	287-881	151	9.00	43.4	11.6	20.2	12.6	479	26	3350@830	7390@120	3075@830	6780@120	65
11R24.5	H	287-873	150	8.25	44.4	11.1	20.9	12.2	468	26	3250@830	7160@120	3000@830	6610@120	65
12R24.5	H	287-903	162	9.00	45.4	11.6	21.2	12.6	458	27	3550@830	7830@120	3250@830	7160@120	65
315/80R22.5	L	001-714	163	9.00	43.3	12.2	20.1	13.4	480	26	4125@900	9090@130	3750@900	8270@130	65

- All dimensions taken with tire on measuring rim.
- Loaded dimensions and RPM measured at maximum dual load.
- For load and inflation tables see pages 91 through 96.
- For minimum dual spacing and approved rim widths see page 74.
- For ply ratings see table on page 72.

Bridgestone tires and tubes are subject to an ongoing development program. Bridgestone Americas Tire Operations, LLC retains the right to amend specifications at any time without notice or obligations. Please refer to rim manufacturer's load and inflation limits. Never exceed rim manufacturer's limits without the consent of the component manufacturer.



**BRIDGESTONE**  
Your Journey, Our Passion

## M840

*On/Off-Highway  
All-Position Radial*

- Deep tread for long tread life.
- Combination rib/lug pattern provides a solid grip in any wheel position.
- Tough tread compounds resist cuts, chips, tearing and irregular wear.
- Split-belt construction for flexibility in enveloping road obstacles leading to better casing durability.

### Recommended Application

An all-position tire recommended for steer, drive and trailer positions in on/off-highway service.

**Replaces:** Goodyear: G288  
Michelin: XZY, XTY2

### TECHNICAL DATA

Tire Size	Load Range	Material Number	Weight* (lbs.)	Meas. Rim	Overall Diam.	Overall Width	Static Loaded Radius	Overall Width (Loaded)	Revs Per Mile	Tread Depth (32')	Max. Tire Load (Single)		Max. Tire Load (Dual)		Max. Speed (MPH)
											Kg/kPa	Lbs/PSI	Kg/kPa	Lbs/PSI	
<b>M840</b>															
12.00R24	J	152-994	186	8.50	48.1	12.1	22.2	13.2	432	23	4250@830	9370@120	3875@830	8540@120	65
275/70R22.5	J	202-451	121	8.25	38.4	10.8	17.8	11.8	541	22	3150@830	6940@120	2900@830	6395@120	65

- All dimensions taken with tire on measuring rim.
- Loaded dimensions and RPM measured at maximum dual load.
- For load and inflation tables see pages 91 through 96.
- For minimum dual spacing and approved rim widths see page 74.
- For ply ratings see table on page 72.



**BRIDGESTONE**  
Your Journey, Our Passion

## M857

**On/Off-Highway  
All-Position Radial**

- Designed for use on dump trucks, logging rigs and refuse vehicles.
- Tough tread compounds provide resistance to cuts, tearing, chips and irregular wear.
- Thick undertread layer for penetration resistance and retreadability.

### Recommended Application

An all-position tire recommended in on/off-highway service.

**Replaces:** Goodyear: G286

### TECHNICAL DATA

Tire Size	Load Range	Material Number	Weight (lbs.)	Meas. Rim	Overall Diam.	Overall Width	Static Loaded Radius	Overall Width (Loaded)	Revs Per Mile	Tread Depth (32")	Max. Tire Load (Single)		Max. Tire Load (Dual)		Max. Speed (MPH)
											Kg/kPa	Lbs/PSI	Kg/kPa	Lbs/PSI	
<b>M857</b>															
11.00R24	H	289-779	158	8.00	46.7	11.5	21.7	12.7	445	20	3750@830	8270@120	3450@830	7610@120	65
255/70R22.5	H	295-876	96	7.50	36.8	9.8	17.5	10.8	565	19	2,500@830	5,510@120	2,300@830	5,070@120	75

- All dimensions taken with tire on measuring rim.
- Loaded dimensions and RPM measured at maximum dual load.
- For load and inflation tables see pages 91 through 96.
- For minimum dual spacing and approved rim widths see page 74.
- For ply ratings see table on page 72.

Bridgestone tires and tubes are subject to an ongoing development program. Bridgestone Americas Tire Operations, LLC retains the right to amend specifications at any time without notice or obligations. Please refer to rim manufacturer's load and inflation limits. Never exceed rim manufacturer's limits without the consent of the component manufacturer.



**BRIDGESTONE**  
Your Journey, Our Passion

## L320

### On/Off-Highway Drive Axle Radial

- Aggressive lug tread for powerful grip on or off the road.
- Deep original tread for long life and outstanding traction.
- Special tread compounds help resist cuts, chips, tearing and irregular wear.
- 65 mph speed rating allows operation at higher sustained speed in on-highway service.

#### Recommended Application

Recommended for drive positions in on/off-highway service.

**Replaces:** Goodyear: G177, G282  
Michelin: XDY3, XDY-EX2, XDL

#### TECHNICAL DATA

Tire Size	Load Range	Material Number	Weight (lbs.)	Meas. Rim	Overall Diam.	Overall Width	Static Loaded Radius	Overall Width (Loaded)	Revs Per Mile	Tread Depth (32')	Max. Tire Load (Single)		Max. Tire Load (Dual)		Max. Speed (MPH)
											Kg/kPa	Lbs/PSI	Kg/kPa	Lbs/PSI	
<b>L320</b>															
12.00R24	J	193-373	202	8.50	48.6	12.2	22.5	13.4	427	31	4250@830	9370@120	3875@830	8540@120	65
11R22.5	G	208-350	143	8.25	42.4	10.8	19.8	11.9	490	31	2800@720	6175@105	2650@720	5840@105	65
11R22.5	H	186-318	143	8.25	42.4	10.8	19.8	11.9	490	31	3000@830	6610@120	2725@830	6005@120	65
12R22.5	H	211-019	163	9.00	43.6	11.5	20.3	12.7	476	31	3350@830	7390@120	3075@830	6780@120	65
11R24.5	H	186-335	156	8.25	44.4	10.8	20.7	11.9	467	31	3250@830	7160@120	3000@830	6610@120	65

- All dimensions taken with tire on measuring rim.
- Loaded dimensions and RPM measured at maximum dual load.
- For load and inflation tables see pages 91 through 96.
- For minimum dual spacing and approved rim widths see page 74.
- For ply ratings see table on page 72.



**BRIDGESTONE**  
Your Journey, Our Passion

## M775

*On/Off-Highway  
Drive Axle Radial*

- Extra-deep tread for long original tread life.
- Aggressive tread design for maximum traction on or off the road.
- Special compounds for resistance to cuts, chips, tearing and irregular wear.
- Split-belt construction for flexibility in enveloping road obstacles leading to better casing durability.
- Stone rejector platforms help prevent retention of casing-damaging stones.

### Recommended Application

Recommended for drive positions in severe service, such as logging and oil field usage.

**Replaces:** Goodyear: G177, G282  
Michelin: XDY-EX2, XDY3, XDY-2

### TECHNICAL DATA

Tire Size	Load Range	Material Number	Weight (lbs.)	Meas. Rim	Overall Diam.	Overall Width	Static Loaded Radius	Overall Width (Loaded)	Revs Per Mile	Tread Depth (32')	Max. Tire Load (Single)		Max. Tire Load (Dual)		Max. Speed (MPH)
											Kg/kPa	Lbs/PSI	Kg/kPa	Lbs/PSI	
<b>M775</b>															
11R22.5	H	202-604	141	8.25	42.6	10.8	19.8	11.9	487	33	3000@830	6610@120	2725@830	6005@120	65
12R22.5	H	202-621	155	9.00	43.7	11.6	20.3	12.7	476	34	3350@830	7390@120	3075@830	6780@120	65
11R24.5	H	157-767	157	8.25	44.6	10.8	20.8	11.9	465	33	3250@830	7160@120	3000@830	6610@120	65

- All dimensions taken with tire on measuring rim.
- Loaded dimensions and RPM measured at maximum dual load.
- For load and inflation tables see pages 91 through 96.
- For minimum dual spacing and approved rim widths see page 74.
- For ply ratings see table on page 72.



**BRIDGESTONE**  
Your Journey, Our Passion

## R244

**On/Off-Highway, Wide Base  
All-Position Radial**

- Rib-type pattern in wide-base design helps deliver a smoother ride with higher payload.
- Special tread compounds for resistance cuts, chips, tearing, and irregular wear.
- Enhanced belt package strengthens footprint to help resist irregular wear, increases tread life, and offers better protection against damaging penetration.
- Optimized casing for improved rolling resistance.
- Groove wall angle increases resistance to stone retention which protects the steel belts and enhance casing durability.

### Recommended Application

A wide base all-position tire recommended for free-rolling axle positions in light on/off-highway services. Recommended in:

**Urban/Regional Haul Service / Pickup & Delivery Service**

**Replaces:** Goodyear: G296 MSA

Michelin: XFE

### TECHNICAL DATA

Tire Size	Load Range	Material Number	Weight (lbs.)	Meas. Rim	Overall Diam.	Overall Width	Static Loaded Radius	Overall Width (Loaded)	Revs Per Mile	Tread Depth (32')	Max. Tire Load (Single)		Max. Tire Load (Dual)		Max. Speed (MPH)
											Kg/kPa	Lbs/PSI	Kg/kPa	Lbs/PSI	
<b>R244</b>															
385/65R22.5	L	225-238	166	12.25	42.8	15.3	19.8	16.8	485	21	4500@900	9920@130	--	--	65
425/65R22.5	L	225-221	184	12.25	44.8	16.1	20.6	17.8	464	21	5150@830	11400@120	--	--	65
445/65R22.5	M	233-687	201	13.00	45.8	17.8	21.0	19.5	454	21	5800@900	12800@130	--	--	65

- All dimensions taken with tire on measuring rim.
- Loaded dimensions and RPM measured at maximum dual load.
- For load and inflation tables see pages 91 through 96.
- For minimum dual spacing and approved rim widths see page 74.
- For ply ratings see table on page 72.



**BRIDGESTONE**  
Your Journey, Our Passion

## M854

*On/Off-Highway, Wide Base  
All-Position Radial*

- Aggressive tread pattern for ideal traction.
- Special on/off-highway cap/base compounds deliver longer tread life, and provide resistance to cuts, chips, tearing, and irregular wear.
- Wide-base design for higher payload and flotation so tires maintain grip and traction without digging into the ground.
- Optimized casing construction controls casing growth which strengthens footprint, improves resistance to irregular wear, and enhance retreadability.
- Stone rejector platforms provide better resistance to stone retention to protect belts from stone damage to enhance casing durability.

### Recommended Application

A wide base all-position tire recommended for steer, drive and trailer positions in on/off-highway service.

**Replaces:** Goodyear: G296  
Michelin: XZY3

### TECHNICAL DATA

Tire Size	Load Range	Material Number	Weight (lbs.)	Meas. Rim	Overall Diam.	Overall Width	Static Loaded Radius	Overall Width (Loaded)	Revs Per Mile	Tread Depth (32')	Max. Tire Load (Single)		Max. Tire Load (Dual)		Max. Speed (MPH)
											Kg/kPa	Lbs/PSI	Kg/kPa	Lbs/PSI	
<b>M854</b>															
385/65R22.5	J	241-439	173	11.75	42.9	15.3	19.8	16.8	485	23	4250@830	9370@120	--	--	65
425/65R22.5	L	233-670	189	12.25	44.8	16.2	20.7	17.3	467	23	5150@830	11400@120	--	--	65
445/65R22.5	M	241-456	217	13.00	45.9	17.8	21.1	19.5	452	23	5800@900	12800@130	--	--	65

- All dimensions taken with tire on measuring rim.
- Loaded dimensions and RPM measured at maximum dual load.
- For load and inflation tables see pages 91 through 96.
- For minimum dual spacing and approved rim widths see page 74.
- For ply ratings see table on page 72.

Bridgestone tires and tubes are subject to an ongoing development program. Bridgestone Americas Tire Operations, LLC retains the right to amend specifications at any time without notice or obligations. Please refer to rim manufacturer's load and inflation limits. Never exceed rim manufacturer's limits without the consent of the component manufacturer.





**BRIDGESTONE**  
Your Journey, Our Passion

## L315

**On/Off-Highway, Wide Base  
Drive Axle Radial**

- Designed for axles carrying extra heavy loads in on/off-highway service.
- Aggressive lug tread design for outstanding traction.
- Special tread compounds for resistance to cuts, chips, tearing and irregular wear.
- Wide base design for higher payload and flotation so tires maintain grip and traction without digging into the ground.

### Recommended Application

An on/off-highway wide base tire recommended for all-wheel-drive vehicles, such as front-discharge cement mixers.

**Replaces:** Goodyear: G178, G286, G296  
Michelin: XZY3

### TECHNICAL DATA

Tire Size	Load Range	Material Number	Weight (lbs.)	Meas. Rim	Overall Diam.	Overall Width	Static Loaded Radius	Overall Width (Loaded)	Revs Per Mile	Tread Depth (32")	Max. Tire Load (Single)		Max. Tire Load (Dual)		Max. Speed (MPH)
											Kg/kPa	Lbs/PSI	Kg/kPa	Lbs/PSI	
<b>L315</b>															
385/65R22.5	J	241-354	196	11.75	43.4	15.5	20.3	17.1	482	30	4250@830	9370@120	--	--	65
425/65R22.5	L	241-371	211	12.25	45.3	16.2	21.1	17.8	462	30	5150@830	11400@120	--	--	65
445/65R22.5	L	199-986	222	13.00	46.4	17.9	21.4	19.7	451	30	5600@830	12,300@120	-	-	65

- All dimensions taken with tire on measuring rim.
- Loaded dimensions and RPM measured at maximum dual load.
- For load and inflation tables see pages 91 through 96.
- For minimum dual spacing and approved rim widths see page 74.
- For ply ratings see table on page 72.

Bridgestone tires and tubes are subject to an ongoing development program. Bridgestone Americas Tire Operations, LLC retains the right to amend specifications at any time without notice or obligations. Please refer to rim manufacturer's load and inflation limits. Never exceed rim manufacturer's limits without the consent of the component manufacturer.



**BRIDGESTONE**  
Your Journey, Our Passion

## L317

Off-Highway  
Drive Axle Radial

- Aggressive lug tread for powerful grip.
- Deep original tread for long life and outstanding traction.
- Split-belt construction for resistance to road hazards.
- Special tread compounds for resistance to cuts, chips, tearing and irregular wear.

### Recommended Application

Recommended for drive positions.

**Replaces:** Goodyear: G177  
Michelin: XDL, XZL

### TECHNICAL DATA

Tire Size	Load Range	Material Number	Weight (lbs.)	Meas. Rim	Overall Diam.	Overall Width	Static Loaded Radius	Overall Width (Loaded)	Revs Per Mile	Tread Depth (32')	Max. Tire Load (Single)		Max. Tire Load (Dual)		Max. Speed (MPH)
											Kg/kPa	Lbs/PSI	Kg/kPa	Lbs/PSI	
<b>L317</b>															
12.00R24 NHS †	J	262-986	202	8.50	49.4	12.6	22.9	13.9	421	39	4250@830	9370@120	3875@830	8540@120	50

† NHS: Not for highway service.

- All dimensions taken with tire on measuring rim.
- Loaded dimensions and RPM measured at maximum dual load.
- For load and inflation tables see pages 91 through 96.
- For minimum dual spacing and approved rim widths see page 74.
- For ply ratings see table on page 72.

Bridgestone tires and tubes are subject to an ongoing development program. Bridgestone Americas Tire Operations, LLC retains the right to amend specifications at any time without notice or obligations. Please refer to rim manufacturer's load and inflation limits. Never exceed rim manufacturer's limits without the consent of the component manufacturer.

# Medium Truck Tire – Discontinued Products

## TECHNICAL DATA

Pattern	Size	Load Range	Material Number	Replace With	Meas. Rim	Overall Diam.	Overall Width	Static Loaded Radius	Loaded Width	Revs Per Mile	Tread Depth
R227	295/75R22.5	H	295-434	R283A Ecopia®	8.25	40.1	11.3	18.7	12.5	518	18
R227FE	295/75R22.5	G	185-825	R283A Ecopia®	8.25	40.1	11.3	18.7	12.5	518	18
R260F	11R22.5	G	158-846	R268 Ecopia®	8.25	41.5	10.8	19.5	11.9	501	22
R260F	11R22.5	H	158-863	R268 Ecopia®	8.25	41.5	10.8	19.5	11.9	501	22
R260F	11R24.5	G	158-880	R268 Ecopia®	8.25	43.6	10.8	20.5	11.9	476	22
R260F	11R24.5	H	158-897	R268 Ecopia®	8.25	43.6	10.8	20.5	11.9	476	22
R260F	295/75R22.5	G	158-829	R268 Ecopia®	8.25	40.6	10.9	19.1	12.1	512	22
R260F	285/75R24.5	G	158-812	R268 Ecopia®	8.25	41.8	10.8	19.7	11.9	497	22
R280	11R22.5	G	183-819	R283A Ecopia®	8.25	41.2	10.8	19.2	11.9	504	18
R280	11R22.5	H	185-281	R283A Ecopia®	8.25	41.2	10.8	19.2	11.9	504	18
R280	11R24.5	G	183-802	R283A Ecopia®	8.25	43.2	10.8	20.2	11.9	481	18
R280	11R24.5	H	185-298	R283A Ecopia®	8.25	43.2	10.8	20.2	11.9	481	18
R280	295/75R22.5	G	180-861	R283A Ecopia®	8.25	40.3	11.0	18.8	12.1	516	18
R280	295/75R22.5	H	185-621	R283A Ecopia®	8.25	40.3	11.0	18.8	12.1	516	18
R280	285/75R24.5	G	180-844	R283A Ecopia®	8.25	41.5	10.8	19.5	11.9	501	18
R280	285/75R24.5	H	224-762	R283A Ecopia®	8.25	41.5	10.8	19.5	11.9	501	18
R283 Ecopia®	11R22.5	G	233-415	R283A Ecopia®	8.25	41.2	11.2	19.2	12.3	504	18
R283 Ecopia®	11R22.5	H	244-261	R283A Ecopia®	8.25	41.2	11.2	19.2	12.3	504	18
R283 Ecopia®	11R24.5	G	233-432	R283A Ecopia®	8.25	43.2	11.2	20.2	12.3	480	18
R283 Ecopia®	11R24.5	H	250-398	R283A Ecopia®	8.25	43.2	11.2	20.2	12.3	480	18
R283 Ecopia®	295/75R22.5	G	233-381	R283A Ecopia®	8.25	40.3	11.4	18.8	12.5	516	18
R283 Ecopia®	295/75R22.5	H	000-590	R283A Ecopia®	8.25	40.3	11.4	18.8	12.5	516	18
R283 Ecopia®	295/75R22.5	H	238-396	R283A Ecopia®	7.50	41.5	10.6	19.1	11.6	501	19
R283 Ecopia®	285/75R24.5	G	233-398	R283A Ecopia®	8.25	41.4	11.1	19.4	12.2	502	18
R283 Ecopia®	285/75R24.5	H	001-307	R283A Ecopia®	8.25	41.5	10.8	19.5	11.9	501	18
R287A	11R22.5	G	224-694	R283A Ecopia®	8.25	41.2	11.2	19.2	12.3	504	16
R287A	11R24.5	G	224-728	R283A Ecopia®	8.25	43.2	11.2	20.2	12.3	481	16
R287A	295/75R22.5	G	224-262	R283A Ecopia®	8.25	40.2	11.0	18.8	12.1	516	16
R287A	295/75R22.5	H	238-107	R283A Ecopia®	8.25	40.2	11.0	18.8	12.1	516	16
R287A	285/75R24.5	G	224-660	R283A Ecopia®	8.25	41.4	10.9	19.4	12.0	502	16

# Medium Truck Tire – Discontinued Products

## TECHNICAL DATA

Pattern	Size	Load Range	Material Number	Replace With	Meas. Rim	Overall Diam.	Overall Width	Static Loaded Radius	Loaded Width	Revs Per Mile	Tread Depth
R250F	9R22.5	F	292-885	R268	6.75	38.3	8.9	18.1	9.7	542	17
R250F	10R22.5	F	292-680	R268	7.50	40.0	9.8	18.7	10.7	519	18
R250F	10R22.5	G	292-729	R268	7.50	40.0	9.8	18.7	10.7	519	18
R250F	11R22.5	G	290-661	R268	8.25	41.3	10.8	19.3	11.8	503	19
R250F	11R22.5	H	290-688	R268 / R250 ED	8.25	41.3	10.8	19.3	11.8	503	19
R250F	12R22.5	H	292-850	R268	9.00	42.7	11.6	19.8	12.6	487	20
R250F	11R24.5	G	290-696	R268	8.25	43.3	10.8	20.3	11.8	480	19
R250F	11R24.5	H	290-718	R268 / R250 ED	8.25	43.3	10.8	20.3	11.8	480	19
R250F	215/75R17.5	G	199-867	R238	6.00	30.5	8.5	14.3	9.3	681	16
R250F	225/70R19.5	F	153-028	R238	6.00	32.2	8.5	15.0	9.4	645	14
R250F	225/70R19.5	G	226-955	R238	6.00	32.2	8.5	15.0	9.4	645	14
R250F	245/70R19.5	F	299-898	R238	6.75	33.4	9.4	15.5	10.3	622	19
R250F	245/70R19.5	G	227-261	R238	6.75	33.4	9.4	15.5	10.3	622	19
R250F	245/70R19.5	H	227-295	R238	6.75	33.4	9.4	15.5	10.3	622	19
R250F	265/70R19.5	G	297-518	R238	7.50	34.3	10.0	15.9	11.0	606	16
R250F	255/70R22.5	H	192-608	R250ED	8.25	36.7	10.3	17.1	11.3	567	18
R250F	275/70R22.5	J	199-952	R250ED	7.50	38.0	10.5	17.6	11.6	547	19
R250F	245/75R22.5	G	292-869	R268	6.75	37.4	9.6	17.6	10.5	555	18
R250F	265/75R22.5	G	292-877	R268	7.50	38.4	10.2	18.0	11.1	541	18
R250F	295/75R22.5	G	289-086	R268	8.25	40.2	11.2	18.8	12.2	517	19
R250F	295/80R22.5	H	292-834	R268	9.00	41.6	11.7	19.4	12.7	499	19
R250F	285/75R24.5	G	290-726	R268	8.25	41.4	10.6	19.4	11.6	502	19
R270	285/75R24.5	G	152-722	-	8.25	41.8	10.7	19.6	11.8	497	22
R270	295/75R22.5	G	152-714	-	8.25	40.4	11.0	18.9	12.1	514	22
R294	215/75R17.5	F	278-971	R250F	6.00	30.5	8.5	14.3	9.4	681	15
R294	255/70R22.5	H	269-867	R250F	8.25	36.7	10.3	17.1	11.3	567	18
R294	275/70R22.5	H	156-450	R250F	8.25	38.0	10.4	17.7	11.5	547	19
R294	305/75R24.5	J	290-963	-	9.00	42.6	11.9	20.0	13.0	488	19
R294	315/80R22.5	J	286-265	-	9.00	42.5	12.3	19.9	13.5	489	19
R296	11R22.5	H	150-142	M843	8.25	41.8	10.6	19.6	11.7	497	22
R296	11R24.5	H	152-765	M843	8.25	43.7	10.7	20.5	11.8	475	22
R296	315/80R22.5	L	153-311	M860A	9.00	42.8	12.2	19.8	13.3	485	23
R287	11R22.5	G	185-723	R283 Ecopia®	8.25	41.2	11.2	19.2	12.3	504	16
R287	11R24.5	G	185-672	R283 Ecopia®	8.25	43.2	11.2	20.2	12.3	481	16
R287	295/75R22.5	G	185-638	R283 Ecopia®	8.25	40.2	11.0	18.8	12.1	517	16
R287	285/75R24.5	G	185-655	R283 Ecopia®	8.25	41.4	10.8	19.4	11.9	502	16

continued next page >>

# Medium Truck Tire – Discontinued Products

## TECHNICAL DATA

Pattern	Size	Load Range	Material Number	Replace With	Meas. Rim	Overall Diam.	Overall Width	Static Loaded Radius	Loaded Width	Revs Per Mile	Tread Depth
L320	11R24.5	G	208-333	-	8.25	44.4	10.8	20.7	11.9	467	31
L317	11R22.5	H	160-614	L320	8.25	42.4	10.7	19.8	11.8	490	31
L317	11R24.5	H	265-578	L320	8.25	44.4	10.6	20.8	11.7	468	31
L355	12.00R24	J	153-001	L320	8.50	48.3	12.3	22.3	13.5	430	26
M774	11R22.5	H	292-567	M775	8.25	42.9	11.2	19.9	12.2	484	33
M774	12R22.5	H	292-583	M775	9.00	43.8	11.6	20.3	12.2	474	34
M774	11R24.5	H	292-575	M775	8.25	44.9	11.2	20.9	12.3	463	33
M711	11R22.5	G	265-225	M799	8.25	41.9	10.7	19.6	11.8	496	26
M711	11R22.5	H	283-681	M799	8.25	41.9	10.7	19.6	11.8	496	26
M711	12R22.5	H	265-241	M799	9.00	43.3	11.5	20.2	12.7	480	28
M711	11R24.5	G	265-233	M799	8.25	43.9	10.7	20.6	11.8	473	26
M711	285/75R24.5	G	283-835	M770	8.25	41.9	10.6	19.6	11.7	496	26
M711	295/75R22.5	G	283-843	M770	8.25	40.6	11.1	18.9	12.2	512	26
M720	11R22.5	G	199-748	M710 Ecopia®	8.25	41.8	11.3	19.5	12.5	497	26
M720	11R24.5	G	199-765	M710 Ecopia®	8.25	43.8	11.2	20.4	12.3	475	26
M720	295/75R22.5	G	292-923	M710 Ecopia®	8.25	40.6	11.3	18.9	12.4	512	26
M720	285/75R24.5	G	292-931	M710 Ecopia®	8.25	41.9	11.2	19.6	12.3	496	26
M724F	8R19.5	F	272-906	-	6.00	33.9	7.9	16.0	8.7	613	20
M724F	245/70R19.5	H	281-107	M724F	7.50	33.5	9.7	15.6	10.4	620	21
M725	11R22.5	G	152-935	M770	8.25	42.1	10.7	19.6	11.7	493	30
M725	11R22.5	H	209-608	M770	8.25	42.1	10.7	19.6	11.7	493	30
M725	11R24.5	G	152-943	M770	8.25	44.1	10.7	20.6	11.7	471	30
M725	295/75R22.5	G	150-940	M770	8.25	40.9	11.3	19.1	12.4	508	30
M725	285/75R24.5	G	150-991	M770	8.25	42.1	11.2	19.7	12.2	493	30
M726 EL	9R22.5	F	199-884	-	6.75	38.8	8.9	18.2	9.8	535	24
M726 EL	10R22.5	G	199-918	M726 ELA	7.50	40.5	9.8	18.9	10.8	513	26
M726 EL	11R22.5	G	186-114	M726 ELA	8.25	42.2	11.2	19.6	12.3	492	32
M726 EL	11R24.5	G	186-131	M726 ELA	8.25	44.2	11.2	20.6	12.3	470	32
M726 EL	11R24.5	H	186-777	M726 ELA	8.25	44.2	11.2	20.6	12.3	470	32
M726 EL	265/75R22.5	G	199-935	-	7.50	38.4	10.0	18.2	11.0	533	26
M726 EL	295/75R22.5	G	186-165	M726 ELA	8.25	40.9	11.3	19.1	12.5	507	32
M726 EL	285/75R24.5	G	186-148	M726 ELA	8.25	42.2	11.3	19.8	12.4	492	32
M726F	10R22.5	F	157-201	M726 ELA	7.50	40.5	9.8	18.9	10.7	513	26
M726F	10R22.5	G	297-569	M726 ELA	7.50	40.5	9.8	18.9	10.7	513	26
M726F	265/75R22.5	G	297-577	-	7.50	38.4	10.0	18.0	10.9	541	26
M726F	9R22.5	F	297-550	-	6.75	38.8	8.9	18.2	9.7	535	24
M843	11R24.5	G	287-865	-	8.25	44.4	11.1	20.9	12.2	468	26
M843	315/80R22.5	L	151-300	M843	9.00	43.3	12.2	20.1	13.4	480	26
M844F	385/65R22.5	J	287-938	M854	11.75	42.8	15.5	19.9	16.6	489	23
M844F	425/65R22.5	L	291-684	M854	12.25	44.8	16.2	20.7	17.3	467	23
M844F	445/65R22.5	L	287-954	M854	13.00	45.9	17.4	21.2	18.5	456	24
M850	11R22.5	H	186-267	M853	8.25	42.0	11.0	19.5	12.0	495	24
M850	11R24.5	H	186-284	M853	8.25	44.0	10.9	20.5	12.0	472	24
M860	315/80R22.5	L	186-301	M860A	8.25	42.2	11.2	19.6	12.3	492	21
M860	425/65R22.5	L	241-473	M860A	12.25	44.9	16.1	20.7	17.8	463	23
M895	225/70R19.5	F	226-989	-	6.00	32.4	8.5	15.1	9.4	642	17

# Medium Truck Tire – Discontinued Products

## TECHNICAL DATA

Pattern	Size	Load Range	Material Number	Replace With	Meas. Rim	Overall Diam.	Overall Width	Static Loaded Radius	Loaded Width	Revs Per Mile	Tread Depth
<b>R180</b>	10R17.5	H	272-922	-	7.50	33.7	10.0	15.7	11.0	616	16
<b>R184</b>	215/75R17.5	H	264-695	<b>R238</b>	6.00	30.6	9.4	14.2	9.4	679	15
<b>R184</b>	235/75R17.5	J	285-315	<b>R238</b>	6.75	31.6	9.4	14.6	10.4	657	16
<b>R184</b>	245/70R17.5	J	158-183	<b>R238</b>	7.50	31.4	10.8	14.4	10.8	662	16
<b>R187F</b>	8R19.5	F	267-775	-	6.00	33.6	8.0	15.8	8.8	618	16
<b>R197</b>	11R22.5	G	208-282	<b>R197 Ecopia®</b>	8.25	40.7	11.3	19.0	12.5	510	11
<b>R197</b>	11R24.5	G	208-299	<b>R197 Ecopia®</b>	8.25	42.8	11.4	20.0	12.5	486	11
<b>R197</b>	295/75R22.5	G	208-265	<b>R197 Ecopia®</b>	8.25	39.7	11.3	18.5	12.5	524	11
<b>R197</b>	285/75R22.5	G	208-316	<b>R197 Ecopia®</b>	8.25	41.0	11.3	19.3	12.4	507	11
<b>R194F</b>	255/70R22.5	H	290-777	<b>R197 Ecopia®</b>	8.25	36.3	10.3	17.0	11.4	572	12
<b>R195F</b>	11R22.5	G	187-338	<b>R197 Ecopia®</b>	8.25	40.9	11.1	19.1	12.2	507	11
<b>R195F</b>	11R24.5	G	187-355	<b>R197 Ecopia®</b>	8.25	42.9	11.1	20.1	12.2	485	11
<b>R195F</b>	255/70R22.5	H	193-424	<b>R197 Ecopia®</b>	8.25	36.3	10.3	16.9	11.3	572	11
<b>R195F</b>	295/75R22.5	G	187-321	<b>R197 Ecopia®</b>	8.25	39.7	11.3	18.5	12.5	522	11
<b>R195F</b>	285/75R24.5	G	187-372	<b>R197 Ecopia®</b>	8.25	40.9	11.4	19.2	12.5	508	11
<b>R194WB</b>	385/65R22.5	J	287-563	-	11.75	42.7	15.2	19.8	16.7	490	16
<b>R194WB</b>	425/65R22.5	J	287-962	-	12.25	44.7	16.3	20.7	17.9	468	16
<b>L312</b>	445/65R22.5	L	272-604	<b>L315</b>	13.00	45.7	17.7	21.1	19.5	458	20
<b>M711WB</b>	385/65R22.5	J	272-566	-	11.75	42.7	14.7	19.8	16.2	490	22
<b>M711WB</b>	425/65R22.5	J	272-574	-	12.25	44.6	16.3	20.6	17.9	469	22
<b>M857WB</b>	445/65R19.5	J	290-432	-	13.00	42.6	17.8	19.6	19.6	491	19
<b>Greatec® M835</b>	445/50R22.5	L	233-517	<b>Greatec® M835A</b>	14.00	39.9	17.7	18.6	19.4	524	23
<b>Greatec® M825</b>	445/50R22.5	L	233-500	<b>Greatec® M835A</b>	14.00	40.4	17.7	18.9	19.4	514	29
<b>Greatec® Drive</b>	445/50R22.5	L	184-023	<b>Greatec® M835A</b>	14.00	40.2	17.4	19.0	18.5	520	26
<b>Greatec® R197</b>	445/50R22.5	L	250-092	<b>Greatec® R197 Ecopia®</b>	14.00	39.2	17.7	18.3	19.4	533	11
<b>Greatec® R135</b>	445/50R22.5	L	250-092	<b>Greatec® R197 Ecopia®</b>	14.00	39.2	17.7	18.3	19.4	533	11
<b>Greatec® R125A</b>	445/50R22.5	L	249-004	<b>Greatec® R197 Ecopia®</b>	14.00	39.5	17.5	18.6	18.5	529	14
<b>Greatec® R125</b>	445/50R22.5	L	233-534	<b>Greatec® R197 Ecopia®</b>	14.00	39.5	17.5	18.6	18.5	529	14
<b>Greatec® Trailer</b>	445/50R22.5	L	183-751	<b>Greatec® R197 Ecopia®</b>	14.00	39.5	17.5	18.6	18.5	523	14



## Commercial Light Truck Tires

<b>Light Truck Tire Size &amp; Availability Chart</b> .....	48
<b>Duravis® R500 HD All-Position Radial</b> .....	49
<b>Duravis® M700 HD/M700</b> .....	50
<b>Duravis® M773 II/M779 All-Season All-Position Radial</b> .....	51
<b>R265 V-Steel Rib</b> .....	52
<b>Blizzak® W965 All-Season Winter All-Position Radial</b> .....	53
<b>Duravis® R238 All-Position Radial</b> .....	55
<i>Commercial Light Truck Tire – Discontinued Products</i> .....	56 - 57



# Light Truck Tire Size & Availability Chart

LOAD RANGE AND TREAD DEPTHS IN 32NDS INDICATE AVAILABILITY							
BRIDGESTONE	COMBINATION POLYESTER & STEEL						ALL-STEEL CASING
	DURAVIS® R500 HD	DURAVIS® M700 HD / M700	DURAVIS® M773 II	DURAVIS® M779	R265 V-STEEL RIB	BLIZZAK® W965	DURAVIS® R238
PAGE	49	50	51	51	52	53	55
REPLACES GOODYEAR	Wrangler SR-A	Wrangler Silent Armor	Wrangler Silent Armor	Wrangler Silent Armor	Wrangler SR-A, G949 RSA	None	G949 RSA
REPLACES MICHELIN	LTX M/S2	LTXA/T2	LTXA/T2	LTXA/T2	LTX M/S2, LTX M/S, XPS Rib	None	XPS Rib
SIZE	LOAD RANGE - TREAD DEPTH						
LT225/75R16	E-14	E-14				E-17	E-14
LT245/75R16	E-17	E-16	E-17		E-14	E-18	E-15
LT265/75R16	E-15	E-17	E-17			E-18	
LT215/85R16	E-14	E-14		E-15		E-17	E-14
LT235/85R16	E-17	E-14				E-18	E-15
LT245/70R17	E-14					E-18	
LT265/70R17	E-15	E-17/E-18				E-18	
LT225/75R17							
LT245/75R17							E-15
LT235/80R17	E-14	E-16				E-14	



**BRIDGESTONE**  
Your Journey, Our Passion

## Duravis® R500 HD

All-Position Radial

- Delivers long mileage with high durability.
- 3-D sipes improve dry traction while enhancing snow, ice and wet traction.
- Dual sidewall protector ribs resist curbing, cuts, and abrasions.
- Stone rejectors protect against stone drilling to enhance casing durability.



Replaces: Goodyear: Wrangler SR-A  
Michelin: LTX M/S 2, LTX M/S

### TECHNICAL DATA

SW Style	Tire Size	Load Range	Service Description	Material Number	Wt. (lbs.)	Measuring Rim	Overall Diam.	Overall Width	Static Loaded Radius	Min. Dual Spac.	Revs Per Mile	Tread Depth (32")	Max. Tire Load (Single)		Max. Tire Load (Dual)	
													Kg/kPa	Lbs/PSI	Kg/kPa	Lbs/PSI
<b>Duravis® R500 HD</b>																
BL	LT225/75R16	E	115/112R	192-659	41	(6.0) 6.0-7.0	29.2	9.0	14.0	10.2	709	14	1215@550	2680@80	1120@550	2470@80
BL	LT245/75R16	E	120/116Q	191-860	47	(7.0) 6.0-7.0	30.6	9.8	14.2	11.3	671	17	1380@550	3042@80	1260@550	2778@80
BL	LT265/75R16	E	123/120R	191-877	53	(7.5) 7.0-8.0	31.6	10.8	14.0	12.2	659	15	1550@550	3415@80	1400@550	3085@80
BL	LT215/85R16	E	115/112R	191-826	41	(6.0) 5.5-7.0	30.3	8.7	14.1	9.9	687	14	1215@550	2680@80	1120@550	2470@80
BL	LT235/85R16	E	120/116Q	191-843	47	(6.5) 6.0-7.0	32.0	9.5	14.8	10.8	651	17	1380@550	3042@80	1260@550	2778@80
BL	LT245/70R17	E	119/116R	191-894	47	(7.0) 6.5-8.0	30.5	10.0	13.7	11.3	683	14	1360@550	3000@80	1250@550	2755@80
BL	LT265/70R17	E	121/118R	191-911	53	(8.0) 7.0-8.5	31.6	11.1	14.1	12.4	659	15	1450@550	3195@80	1320@550	2910@80
BL	LT235/80R17	E	120/117R	191-928	47	(6.5) 6.0-7.0	31.7	9.5	14.1	10.8	657	14	1400@550	3085@80	1285@550	2835@80

- All dimensions taken with tire on measuring rim (in parenthesis above).
- Loaded dimensions and RPM measured at maximum dual load.
- For load and inflation tables see pages 97 through 100.

Bridgestone tires and tubes are subject to an ongoing development program. Bridgestone Americas Tire Operations, LLC retains the right to amend specifications at any time without notice or obligations. Please refer to rim manufacturer's load and inflation limits. Never exceed rim manufacturer's limits without the consent of the component manufacturer.



**BRIDGESTONE**  
Your Journey, Our Passion

## Duravis® M700 HD/M700

- Closed shoulder slots contribute to long tread life.
- Stone rejectors help protect against damaging stone drilling.
- Dual sidewall projectors resist cuts and abrasions.
- Stepped tread block edges increase snow traction.

*Replaces:* Goodyear: Wrangler Silent Armor  
Michelin: LTX A/T 2

Duravis® M700 HD

Duravis® M700

### TECHNICAL DATA

SW Style	Tire Size	Load Range	Service Description	Material Number	Wt. (lbs.)	Measuring Rim	Overall Diam.	Overall Width	Static Loaded Radius	Min. Dual Spac.	Revs Per Mile	Tread Depth (32")	Max. Tire Load (Single)		Max. Tire Load (Dual)	
													Kg/kPa	Lbs/PSI	Kg/kPa	Lbs/PSI
<b>Duravis® M700 HD</b>																
BL	LT225/75R16	E	115/112R	213-518	42	(6.0) 6.0-7.0	29.3	9.0	13.7	10.2	711	14	1215@550	2680@80	1120@550	2470@80
BL	LT245/75R16	E	120/116R	206-310	48	(7.0) 6.5-8.0	30.5	10.0	14.2	11.3	683	16	1380@550	3042@80	1260@550	2778@80
BL	LT265/75R16	E	123/120R	206-293	54	(7.5) 7.0-8.0	31.7	10.8	14.7	12.2	657	17	1550@550	3415@80	1400@550	3085@80
BL	LT215/85R16	E	115/112R	214-606	42	(5.5) 6.5-7.0	30.4	8.7	14.1	9.9	685	14	1215@550	2680@80	1120@550	2470@80
BL	LT235/85R16	E	120/116R	214-589	48	(6.5) 5.5-7.0	31.7	9.5	14.0	10.8	657	14	1380@550	3042@80	1260@550	2778@80
BL	LT265/70R17	E	121/118R	206-276	54	(8.0) 7.0-8.5	31.7	11.1	14.7	12.4	657	17	1450@550	3195@80	1320@550	2910@80
BL	LT235/80R17	E	120/117R	206-242	50	(6.5) 6.0-7.5	31.9	9.4	14.8	10.8	653	16	1400@550	3085@80	1285@550	2835@80
<b>Duravis® M700 OEM</b>																
BL	LT265/70R17	E	121/118Q	190-840	48	(7.0) 6.5-8.0	31.7	10.7	14.7	12.4	657	18	1450@550	3195@80	1320@550	2910@80

- All dimensions taken with tire on measuring rim (in parenthesis above).
- Loaded dimensions and RPM measured at maximum dual load.
- For load and inflation tables see pages 97 through 100.

Bridgestone tires and tubes are subject to an ongoing development program. Bridgestone Americas Tire Operations, LLC retains the right to amend specifications at any time without notice or obligations. Please refer to rim manufacturer's load and inflation limits. Never exceed rim manufacturer's limits without the consent of the component manufacturer.



**BRIDGESTONE**  
Your Journey, Our Passion

## Duravis® M773 II/ M779 All-Season All-Position Radial

- All-season on-highway design for traction in rain, snow and icy conditions.
- Recommended for delivery vehicles, vans and moving trucks.
- Combination steel belts and polyester body plies for durability and long life.
- SWP II: Enhanced construction for heavier-duty applications.

*Replaces:* Goodyear: Wrangler Silent Armor  
Michelin: LTX A/T 2

### TECHNICAL DATA

SW Style	Tire Size	Load Range	Service Description	Material Number	Wt. (lbs.)	Measuring Rim	Overall Diam.	Overall Width	Static Loaded Radius	Min. Dual Spac.	Revs Per Mile	Tread Depth (32')	Max. Tire Load (Single)		Max. Tire Load (Dual)	
													Kg/kPa	Lbs/PSI	Kg/kPa	Lbs/PSI
<b>Duravis® M773 II</b>																
BL	LT245/75R16	E	120/116R	208-231	41	(7.0) 6.5-7.5	30.5	9.8	14.2	11.3	683	17	1380@550	3042@80	1260@550	2778@80
BL	LT265/75R16	E	123/120Q	185-230	48	(7.5) 7.0-8.0	31.2	10.4	14.5	12.2	668	17	1550@550	3415@80	1400@550	3085@80
<b>M779 All-Season</b> not pictured																
BL	LT215/85R16	E	115/112P	293-695	45	(6.0) 5.0-6.0	30.5	8.5	14.2	9.9	673	15	1215@550	2680@80	1120@550	2470@80

- All dimensions taken with tire on measuring rim (in parenthesis above).
- Loaded dimensions and RPM measured at maximum dual load.
- For load and inflation tables see pages 97 through 100.

Bridgestone tires and tubes are subject to an ongoing development program. Bridgestone Americas Tire Operations, LLC retains the right to amend specifications at any time without notice or obligations. Please refer to rim manufacturer's load and inflation limits. Never exceed rim manufacturer's limits without the consent of the component manufacturer.



**BRIDGESTONE**  
Your Journey, Our Passion

## R265 V-Steel Rib

- Radial rib light truck tire for use on-highway when heavy loads are present.
- Steel belts ensure stability and durability at highway speeds.

**Replaces:** Goodyear: Wrangler SR-A, G949 RSA  
Michelin: LTX M/S 2, LTX M/S, XPS Rib

### TECHNICAL DATA

SW Style	Tire Size	Load Range	Service Description	Material Number	Wt. (lbs.)	Measuring Rim	Overall Diam.	Overall Width	Static Loaded Radius	Min. Dual Spac.	Revs Per Mile	Tread Depth (32")	Max. Tire Load (Single)		Max. Tire Load (Dual)	
													Kg/kPa	Lbs/PSI	Kg/kPa	Lbs/PSI
<b>R265 V-Steel Rib</b>																
BL	LT245/75R16	E	120/116S	154-075	41	(6.5) 6.0-7.0	30.5	9.8	14.4	11.3	682	14	1380@550	3042@80	1260@550	2778@80

- All dimensions taken with tire on measuring rim (in parenthesis above).
- Loaded dimensions and RPM measured at maximum dual load.
- For load and inflation tables see pages 97 through 100.

Bridgestone tires and tubes are subject to an ongoing development program. Bridgestone Americas Tire Operations, LLC retains the right to amend specifications at any time without notice or obligations. Please refer to rim manufacturer's load and inflation limits. Never exceed rim manufacturer's limits without the consent of the component manufacturer.



**BRIDGESTONE**  
Your Journey, Our Passion

## Blizzak® W965 All-Season Winter All-Position Radial

- Winter grip for light truck commercial applications.
- Tube multi-cell compound improves control on ice by cutting through thin layers of water.
- Zig-Zag siping for improved ice performance.



Meets the severe snow service requirements of the Rubber Manufacturers Association (RMA) and the Rubber Association of Canada (RAC).



### TECHNICAL DATA

SW Style	Tire Size	Load Range	Service Description	Material Number	Wt. (lbs.)	Measuring Rim	Overall Diam.	Overall Width	Static Loaded Radius	Min. Dual Spac.	Revs Per Mile	Tread Depth (32")	Max. Tire Load (Single)		Max. Tire Load (Dual)	
													Kg/kPa	Lbs/PSI	Kg/kPa	Lbs/PSI
<b>Blizzak® W965 All-Season Winter</b>																
BL	LT225/75R16	E	115/112Q	150-797	43	(6.0) 6.0-7.0	29.4	8.7	10.2	13.7	709	17	1215@550	2680@80	1120@550	2470@80
BL	LT245/75R16	E	120/116Q	150-800	49	(7.0) 6.5-7.5	30.6	9.6	14.2	11.3	681	18	1380@550	3042@80	1260@550	2778@80
BL	LT265/75R16	E	123/120Q	156-477	54	(7.5) 7.0-8.0	31.9	10.5	14.8	12.2	653	18	1550@550	3415@80	1400@550	3085@80
BL	LT235/80R17	E	120/117Q	214-963	47	(6.5) 6.0-7.5	31.8	9.3	14.8	10.8	655	14	1400@550	3085@80	1285@550	2835@80
BL	LT215/85R16	E	115/112Q	150-770	48	(6.0) 5.5-7.0	30.6	8.6	14.2	9.9	681	17	1215@550	2680@80	1120@550	2470@80
BL	LT235/85R16	E	120/116Q	150-789	53	(6.5) 6.0-7.0	31.8	9.3	14.7	10.8	655	18	1380@550	3042@80	1260@550	2778@80
BL	LT245/70R17	E	119/116Q	200-479	52	(7.0) 6.5-8.0	30.8	9.8	14.4	11.3	676	18	1360@550	3000@80	1250@550	2755@80
BL	LT265/70R17	E	121/118Q	207-585	52	(8.0) 7.0-8.5	31.9	10.7	14.8	12.4	653	18	1450@550	3195@80	1320@550	2910@80

- All dimensions taken with tire on measuring rim (in parenthesis above).
- Loaded dimensions and RPM measured at maximum dual load.
- For load and inflation tables see pages 97 through 100.

Bridgestone tires and tubes are subject to an ongoing development program. Bridgestone Americas Tire Operations, LLC retains the right to amend specifications at any time without notice or obligations. Please refer to rim manufacturer's load and inflation limits. Never exceed rim manufacturer's limits without the consent of the component manufacturer.





**BRIDGESTONE**  
Your Journey, Our Passion

## Duravis® R238

All-Position Radial

- Enhanced tread compound delivers up to 17% improved tread life, shown in tests with previous generation tires (Duravis R250).
- All-steel light truck radial provides heavy duty construction for rigorous driving conditions.
- An on-highway radial tire for service in commercial applications.
- Thick gauge sidewall and dual sidewall protector ribs help to make tire more cut, chip and tear resistant.
- Designed for pickup and delivery, regional and long haul service.

*Replaces:* Goodyear: G949 RSA  
Michelin: XPS Rib

### TECHNICAL DATA

SW Style	Tire Size	Load Range	Service Description	Material Number	Wt. (lbs.)	Measuring Rim	Overall Diam.	Overall Width	Static Loaded Radius	Min. Dual Spac.	Revs Per Mile	Tread Depth (32')	Max. Tire Load (Single)		Max. Tire Load (Dual)	
													Kg/kPa	Lbs/PSI	Kg/kPa	Lbs/PSI
<b>Duravis® R238</b>																
BL	LT225/75R16	E	115/112Q	002-038	50	(6.0) 6.0-7.0	29.3	8.8	13.7	10.2	711	14	1215@550	2680@80	1120@550	2470@80
BL	LT245/75R16	E	120/116Q	002-036	54	(7.0) 6.5-8.0	30.5	9.8	14.2	11.3	684	15	1380@550	3042@80	1260@550	2778@80
BL	LT215/85R16	E	115/112Q	002-043	52	(6.0) 5.5-7.0	30.4	8.5	14.2	9.9	685	14	1215@550	2680@80	1120@550	2470@80
BL	LT235/85R16	E	120/116Q	002-044	56	(6.5) 6.0-7.5	31.7	9.3	14.7	10.8	656	15	1380@550	3042@80	1260@550	2778@80
BL	LT245/75R17	E	121/118Q	002-039	56	(7.0) 6.5-7.5	31.5	9.8	14.7	11.3	661	15	1450@550	3195@80	1320@2550	2910@80

- All dimensions taken with tire on measuring rim (in parenthesis above).
- Loaded dimensions and RPM measured at maximum dual load.
- For load and inflation tables see pages 97 through 100.

Bridgestone tires and tubes are subject to an ongoing development program. Bridgestone Americas Tire Operations, LLC retains the right to amend specifications at any time without notice or obligations. Please refer to rim manufacturer's load and inflation limits. Never exceed rim manufacturer's limits without the consent of the component manufacturer.



# Commercial Light Truck — Discontinued Products Continued

## TECHNICAL DATA

Pattern	Size	Load Range	Approved Rims	Overall Diam.	Overall Width	Static Loaded Radius	Revs Per Mile	Min. Duel Spacing	Tread Depth
<b>Dueler 661</b>	LT235/75R15	C	(6.0) 6.0-7.0	29.0	9.0	13.3	728	10.8	14
<b>Dueler 661</b>	LT195/75R16	D	(5.5) 5.0-6.0	26.2	7.6	12.3	796	8.9	14
<b>Dueler 661</b>	LT225/75R16	C	(6.0) 6.0-7.0	29.4	8.7	13.9	709	10.2	14
<b>Dueler 661</b>	LT225/75R16	D	(6.0) 6.0-7.0	29.4	8.7	13.9	709	10.2	14
<b>Dueler 661</b>	LT245/75R16	E	(7.0) 6.5-7.0	30.6	9.6	14.4	682	11.3	16
<b>Dueler 661</b>	LT215/85R16	D	(6.0) 5.0-6.0	30.6	8.2	14.5	687	9.9	15
<b>Dueler 661</b>	LT215/85R16	E	(6.0) 5.0-6.0	30.6	8.2	14.5	687	9.9	15
<b>Dueler 661</b>	LT235/85R16	D	(6.5) 6.0-7.0	31.8	9.1	14.8	660	10.8	16
<b>Dueler 661</b>	LT235/85R16	E	(6.5) 6.0-7.0	31.8	9.1	14.8	660	10.8	16
<b>Dueler 661</b>	8.75R16.5LT	D	(6.75) 6.0-6.75	29.4	8.9	13.9	709	9.9	15
<b>Dueler 661</b>	8.75R16.5LT	E	(6.75) 6.0-6.75	29.4	8.9	13.9	709	9.9	15
<b>Dueler 661</b>	9.50R16.5LT	D	(6.75) 6.75-8.25	30.6	9.5	14.4	682	10.7	15
<b>Dueler 661</b>	9.50R16.5LT	E	(6.75) 6.75-8.25	30.6	9.5	14.4	682	10.7	15
<b>R273 SWP</b>	LT235/85R16	E	(6.5) 6.0-7.0	31.7	9.3	14.7	641	10.8	14
<b>R273 SWP</b>	LT235/85R16	D	(6.5) 6.0-7.0	31.7	9.3	14.7	641	10.8	14
<b>R273 SWP</b>	LT215/85R16	E	(6.0) 5.0-6.0	30.4	8.5	14.1	677	10.8	14
<b>R273 SWP</b>	LT225/75R16	E	(6.0) 6.0-7.0	29.3	8.8	13.6	708	10.2	14
<b>R273 SWP</b>	LT245/75R16	E	(7.0) 6.5-7.0	30.5	9.8	14.1	675	11.3	14
<b>R273 SWP</b>	8.75R16.5LT	D	(6.75) 6.0-6.75	29.5	8.8	13.8	703	9.9	14
<b>R273 SWP</b>	8.75R16.5LT	E	(6.75) 6.0-6.75	29.5	8.8	13.8	703	9.9	14
<b>R273 SWP</b>	9.50R16.5LT	D	(6.75) 6.75-8.25	30.6	9.5	14.2	672	10.7	14
<b>R273 SWP</b>	9.50R16.5LT	E	(6.75) 6.75-8.25	30.6	9.5	14.2	672	10.7	14
<b>R273 SWP</b>	7.50R16LT	D	(6.0) 5.5-6.5	31.8	8.7	14.7	638	10	14
<b>R273 SWP</b>	LT215/85R16	D/E	(6.0) 5.0-6.0	30.4	8.5	14.1	677	9.9	14
<b>R273 SWP</b>	8R17.5	E	(6.0) 5.25-6.75	30.8	8.2	13.9	674	9.2	12
<b>R273 SWP</b>	LT235/75R15	D	(6.5) 6.0-7.0	28.9	9.3	13.4	720	10.8	14
<b>R273 SWP II</b>	LT215/85R16	E	(6.5) 6.0-7.0	30.4	8.7	14.1	685	9.9	14
<b>R273 SWP II</b>	LT225/75R16	E	(6.0) 6.0-7.0	29.3	8.8	13.7	711	10.2	14
<b>R273 SWP II</b>	LT235/85R16	E	(6.5) 6.0-7.0	31.7	9.5	14.8	651	10.8	14
<b>R273 SWP II</b>	LT245/75R16	E	(7.0) 6.5-7.0	30.6	9.8	14.2	681	11.3	14
<b>DURAVIS R500 HD</b>	LT275/65R18	E	(8.0) 7.5-9.0	32.1	11.0	15.0	649	12.8	14
<b>DURAVIS M700 HD</b>	LT275/65R18	E	(8.0) 7.5-9.0	32.1	11.0	15.0	649	12.8	16
<b>DURAVIS M895</b>	LT225/75R16	E	(6.0) 6.0-7.0	29.4	8.8	13.6	10.2	711	14
<b>DURAVIS M895</b>	LT245/75R16	E	(7.0) 6.0-7.5	30.8	9.8	14.1	11.3	684	15
<b>DURAVIS M895</b>	LT215/85R16	E	(6.0) 5.5-7.0	30.5	8.5	14.1	9.9	685	14
<b>DURAVIS M895</b>	LT235/85R16	E	(7.0) 6.5-7.5	30.5	9.3	14.7	10.8	656	15
<b>M773 SWP</b>	LT235/75R15	C	(6.5) 6.0-7.0	29.0	9.3	13.4	716	10.8	16
<b>M773 SWP</b>	LT235/85R16	E	(6.5) 6.0-7.0	31.8	9.3	14.7	651	10.8	17
<b>M773 SWP</b>	LT245/75R16	E	(7.0) 6.5-7.0	30.6	9.8	14.2	711	11.3	17
<b>M773 SWP</b>	LT215/85R16	E	(6.0) 5.0-6.0	30.5	8.5	14.2	673	9.9	16
<b>M773 SWP</b>	LT225/75R16	D/E	(6.0) 6.0-7.0	29.4	8.8	13.7	704	10.2	16
<b>M773 SWP</b>	LT235/85R16	D	(6.5) 6.0-7.0	31.8	9.3	14.7	637	10.8	17
<b>M773 SWP</b>	7.50R16LT	D	(6.0) 5.5-6.5	31.9	8.7	14.8	633	10.0	16

# Commercial Light Truck — Discontinued Products Continued

## TECHNICAL DATA

Pattern	Size	Load Range	Approved Rims	Overall Diam.	Overall Width	Static Loaded Radius	Revs Per Mile	Min. Duel Spacing	Tread Depth
<b>M773 SWP</b>	8.75R16.5LT	D/E	(6.75) 6.0-6.75	29.6	8.8	13.8	699	9.9	14
<b>M773 SWP</b>	8.75R16.5LT	E	(6.75) 6.0-6.75	29.6	8.8	13.8	699	9.9	14
<b>M773 SWP</b>	9.50R16.5LT	D	(6.75) 6.75-8.25	30.7	9.5	14.3	668	10.7	17
<b>M773 SWP</b>	9.50R16.5LT	E	(6.75) 6.75-8.25	30.7	9.5	14.3	668	10.7	17
<b>M773 SWP</b>	8R17.5	E	(6.0) 5.25-6.75	31.0	8.2	13.8	670	9.9	14
<b>M773 SWP II</b>	LT245/75R16	E	(7.0) 6.0-7.0	30.6	9.8	14.2	671	11.3	17
<b>M773 SWP II</b>	LT215/85R16	E	(6.0) 5.0-6.0	30.4	8.7	14.1	685	9.9	17
<b>M773 SWP II</b>	LT225/75R16	E	(6.0) 6.0-7.0	29.3	8.8	13.7	711	10.2	17
<b>M773 SWP II</b>	LT235/85R16	E	(6.0) 6.0-7.0	32.0	9.5	14.8	651	10.8	17
<b>DURAVIS M773 II</b>	LT245/75R16	E	(7.0) 6.5-7.5	30.5	9.8	14.2	683	11.3	17
<b>DURAVIS R250</b>	LT225/75R16	E	(6.0) 6.0-7.0	29.4	9.0	13.7	709	10.2	13
<b>DURAVIS R250</b>	LT245/75R16	E	(7.0) 6.5-7.5	30.7	10.0	14.2	677	11.3	14
<b>DURAVIS R250</b>	LT265/75R16	E	(7.5) 7.0-8.0	31.9	10.7	14.8	651	12.2	15
<b>DURAVIS R250</b>	LT215/85R16	E	(6.0) 5.5-7.0	30.5	8.5	14.2	683	9.9	13
<b>DURAVIS R250</b>	LT235/85R16	E	(6.5) 6.0-7.5	31.8	9.3	14.7	655	10.8	14
<b>DURAVIS R250</b>	LT225/75R17	E	(6.0) 6.5-7.5	30.3	8.8	14.2	687	10.2	13
<b>DURAVIS R250</b>	LT245/75R17	E	(7.0) 6.5-7.5	31.5	9.8	14.7	661	11.3	14
<b>R220</b>	7.50R16LT	G	(6.0) 5.5-6.5	31.7	8.1	14.9	659	10.0	12
<b>R230</b>	7.50R16LT	D	(6.0) 5.5-6.5	31.7	8.4	14.9	659	10.0	14
<b>R230</b>	7.50R16LT	F	(6.0) 5.5-6.5	31.7	8.4	14.9	659	10.0	14
<b>R230</b>	7.00R15LT	D	(5.5) 5.0-6.5	29.6	7.8	13.9	706	9.0	13
<b>R260</b>	8.00R-16.5LT	D	(6.75) 6.0	28.0	8.1	13.1	743	9.0	12
<b>R260</b>	8.75R16.5LT	D	(6.75) 6.0-6.75	28.0	8.1	13.1	743	9.0	12
<b>R260</b>	8.75R16.5LT	E	(6.75) 6.0-6.75	29.3	8.9	13.8	712	9.9	13
<b>R260</b>	9.50R16.5LT	D	(6.75) 6.75-8.25	30.4	9.5	14.3	686	10.7	13
<b>R260</b>	9.50R16.5LT	E	(6.75) 6.75-8.25	30.4	9.5	14.3	686	10.7	13
<b>R265</b>	LT235/85R16	D	(6.5) 6.0-7.0	31.7	9.3	14.9	659	10.8	14
<b>R265</b>	LT245/75R16	E	(7.0) 6.5-7.0	30.5	9.8	14.4	682	11.3	15
<b>R265</b>	LT245/75R16	E	(7.0) 6.5-7.0	30.5	9.8	14.4	682	11.3	15
<b>R265</b>	8R17.5	E	(6.0) 5.25-6.75	30.8	8.0	14.5	674	9.2	12
<b>R265 V-STEEL</b>	8R17.5	E	(6.0) 5.25-6.75	30.8	8.0	14.5	674	9.2	12
<b>R265 V-STEEL</b>	LT215/85R16	D	(6.0) 5.0-6.0	30.5	8.5	14.3	674	9.9	13
<b>R265 V-STEEL</b>	LT235/85R16	E	(6.5) 6.0-7.0	31.7	9.3	14.9	659	10.8	14
<b>R265 V-STEEL</b>	LT225/75R16	D	(6.0) 6.0-7.0	29.3	8.8	13.9	709	10.2	14
<b>R265 V-STEEL</b>	LT225/75R16	E	(6.0) 6.0-7.0	29.3	8.8	13.9	709	10.2	14
<b>R250</b>	LT245/75R16	E	(7.0) 6.5-7.0	30.7	10	14.2	677	11.3	14
<b>R250</b>	LT265/75R16	E	(7.5) 7.0-8.0	31.9	10.7	14.8	651	12.2	15
<b>VSXA</b>	8R17.5	E	(6.0) 5.25-6.75	31.0	7.8	14.6	673	9.2	18
<b>VSXA</b>	7.50R16	G	(6.0) 5.5-7.0	31.9	8.4	15.0	654	10.0	18
<b>VSXC</b>	7.50R16	D	(6.0) 5.5-6.5	31.9	8.4	15	654	10	18
<b>VSXC</b>	7.50R16	E	(6.0) 5.5-6.5	31.9	8.4	15	654	10	18
<b>VSXC</b>	LT235/85R16	E	(6.5) 6.0-7.0	32	9.3	14.9	657	10.8	18
<b>R187</b>	LT225/75R16	E	(6.0) 6.0-7.0	29.3	8.8	13.8	711	10.2	14
<b>R187</b>	LT235/85R16	E	(6.5) 6.0-7.0	31.7	9.3	14.8	660	9.9	15
<b>R187</b>	LT225/75R16	E	(6.0) 6.0-7.0	29.3	8.8	13.8	711	10.8	14



## General Technical Information

Adjustment Treadwear Chart .....	60
Limited Warranty – Bridgestone® Truck Tires.....	61 - 68
Commercial Tire Tubes, Valves & Flaps .....	69
Radial & Bias Tire Construction.....	69
Definitions .....	70 - 71
Ply Rating/Load Range.....	72
Speed Symbol .....	72
Load Index .....	72
Inflation Pressure .....	73
Tire Mixing .....	73
Dual Matching.....	73
Medium Truck Tire Approved Rim Width & Minimum Dual Spacing.....	74
Tire Rotation .....	75
Regrooving.....	75
Branding.....	75
Wheel Alignment .....	76
Balance/Runout.....	77
Tire Mounting for Low Vibration.....	78 - 79
Storage .....	80
Tire Inspection.....	80
Irregular Wear of Radial Truck Tires.....	81
Low Profile Tires .....	81
Mounting/Demounting Procedures.....	82 - 83
Tire Vibration.....	84
Repair & Retreading.....	84
Large Truck Fuel Economy .....	85 - 89
Truck Type by Weight Class .....	90

# Adjustment Treadwear Chart

## ORIGINAL TREAD DEPTH

REMAINING TREAD DEPTH	9	10	11	12	13	14	15	16	17	18	19	20	21	22	23	24	25	26	27	28	29	30	31	32	33	34	REMAINING TREAD DEPTH
	<b>Percentage of Usable Tread Wear Charges to the Customer</b>																										
2/32	100%	100	100	100	100	100	100	100	100	100	100	100	100	100	100	100	100	100	100	100	100	100	100	100	100	100	2/32
3/32	86%	88	89	90	91	92	92	93	93	94	94	94	95	95	95	95	96	96	96	96	96	96	97	97	97	97	3/32
4/32	71%	75	78	80	82	83	85	86	87	88	88	89	89	90	90	91	91	92	92	92	93	93	93	93	94	94	4/32
5/32	57%	63	67	70	73	75	77	79	80	81	82	83	84	85	86	86	87	88	88	88	89	89	90	90	90	91	5/32
6/32	43%	50	58	60	64	67	69	71	73	75	76	78	79	80	81	82	83	83	84	85	85	86	86	87	87	88	6/32
7/32	29%	38	44	50	55	58	62	64	67	69	71	72	73	75	76	77	78	79	80	81	81	82	83	83	84	84	7/32
8/32	14%	25	33	40	45	50	54	57	60	63	65	67	68	70	71	73	74	75	76	77	78	79	79	80	81	81	8/32
9/32	0%	13	22	30	36	42	46	50	53	56	59	61	63	65	67	68	70	71	72	73	74	75	76	77	77	78	9/32
10/32		0	11	20	27	33	38	43	47	50	53	56	58	60	62	64	65	67	68	69	70	71	72	73	74	75	10/32
11/32			0	10	18	25	31	36	40	44	47	50	53	55	57	59	61	63	64	65	67	68	69	70	71	72	11/32
12/32				0	9	17	23	25	33	38	41	44	47	50	52	55	57	58	60	62	63	64	66	67	68	69	12/32
13/32					0	8	15	21	29	31	35	39	42	45	48	50	52	54	56	58	59	61	62	63	65	66	13/32
14/32						0	8	14	20	25	29	33	37	40	43	45	48	50	52	54	56	57	59	60	61	63	14/32
15/32							0	7	13	19	24	28	32	35	38	41	43	46	48	50	52	54	55	57	58	59	15/32
16/32								0	7	13	17	22	26	30	33	36	39	42	44	46	48	50	52	53	55	56	16/32
17/32									0	6	12	18	21	25	29	32	35	38	40	42	44	46	48	50	52	53	17/32
18/32										0	6	11	16	20	24	27	30	33	36	38	41	43	45	47	48	50	18/32
19/32											0	6	11	15	19	23	26	29	32	35	37	39	41	43	45	47	19/32
20/32												0	5	10	14	18	22	25	28	31	33	36	38	40	42	44	20/32
21/32													0	5	10	14	17	21	24	27	30	32	34	37	39	41	21/32
22/32														0	5	9	13	17	20	23	26	29	31	33	35	38	22/32
23/32															0	5	9	13	16	19	22	25	28	30	32	34	23/32
24/32																0	4	8	12	15	19	21	24	27	29	31	24/32
25/32																	0	4	8	12	15	18	21	23	26	28	25/32
26/32																		0	4	8	11	14	17	20	23	25	26/32
27/32																			0	4	7	11	14	17	19	22	27/32
28/32																				0	4	7	10	13	16	19	28/32
29/32																					0	4	7	10	13	16	29/32
30/32																						0	3	7	10	13	30/32
31/32																							0	3	6	9	31/32
32/32																								0	3	6	32/32
33/32																									0	3	33/32
34/32																										0	34/32

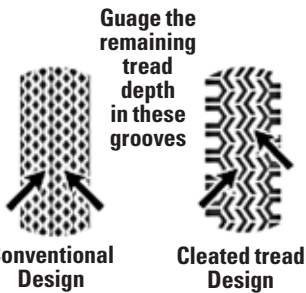

### How To Calculate Adjusted Prices

1. Find the original tread depth in the price/data book.
2. Using 32nds gauge, measure the remaining tread at three points in the two center grooves and average the three measurements.
3. Where the averaged tread depth remaining line meets the appropriate original tread depth column, the percentage of tread worn off the tire will be found.
4. Use this percentage to calculate the customer's replacement price.

### With a tire-marking crayon, mark on the adjusted tire:

1. Location of the service condition (circled).
2. Adjustment Claim Number
3. Retailer Name
4. Rub across the DOT serial number so it can be easily read.

**Make sure the customer COMPLETES and SIGNS the CUSTOMER section of the Adjustment Form!**

# Limited Warranty – Bridgestone® Truck Tires

## Eligibility

You are covered under the terms of this Limited Warranty if all of the following apply:

- You are the original owner, or original owner's authorized agent, of any new Bridgestone brand truck tire bearing a Department of Transportation (DOT) tire identification number indicating manufacture after January 1, 2011 (DOT serial 0111 or later). For tires covered prior to this time, please refer to the limited warranty that would have been in effect at the time of original sale.
- The tire was purchased after January 1, 2012.
- The tire size, load range, and speed rating are equivalent to or greater than, that specified or recommended for use by the vehicle manufacturer or Bridgestone.
- The new tire was approved for sale in the United States, listed in a U.S. price or data book, and purchased from an authorized Bridgestone brand truck tire retailer.
- For coverage under the Enhanced Casing Limited Warranty, the eligible tire must have been used only in long haul, regional, P&D highway service for the entire life of the casing and subsequent retread(s) must be inspected and retreaded by an authorized Bandag dealer only.
- For coverage under the "Premium Casing Enhanced Limited Warranty" that was in effect for certain patterns and certain sizes purchased between 11/1/2007 and 1/1/2012, refer to the Bridgestone Truck Tire Limited Warranty that would have been in effect at the time of the original sale.

## What Is Warranted & For How Long

Upon examination by Bridgestone, before wearing down to 2/32 inch (1.6 mm) remaining original tread depth (i.e. worn down to the top of the built-in indicators in the original tread grooves) and within six years (seven years for certain tires, see the section entitled "Enhanced Casing Limited Warranty") from the date of tire manufacture, any eligible tire that becomes unusable for any reason (see exclusions in the section entitled "What This Limited Warranty Does Not Cover") within the manufacturer's control will either be repaired or replaced with an equivalent new Bridgestone brand truck tire on the basis set forth in this Limited Warranty.

## What This Limited Warranty Does Not Cover

This Limited Warranty does not cover the following:

1. Tire damage due to:
  - A. **Road hazards**, including, without limitation: Puncture, cut, impact break, stone drill, bruise, bulge, snag, etc.

- B. **Improper use or operation**, including, without limitation: Improper inflation pressure, overloading, tire/wheel spinning, curbing, use of an improper rim/wheel, tire chain damage, misuse, misapplication, negligence, tire alteration, or for racing or competition purposes.

- C. **Insufficient or improper maintenance**, including, without limitation: Wheel misalignment, worn suspension components, improper tire mounting or demounting, tire/wheel assembly imbalance, improper brake adjustment, or other vehicle conditions, defects, or characteristics.

- D. **Contamination or degradation** by petroleum products or other chemicals, fire or other externally generated heat, or water or other material trapped inside the tire during mounting or inflation.

2. Irregular wear, rapid wear, or wear-out; no mileage warranty is expressed or implied.
3. Weather/ozone cracking after four years from date of tire manufacture.
4. Tires subjected to severe under-inflation or run-flat conditions.
5. Tires that have been improperly repaired.
6. Tires rendered unretreadable due to excessive tread wear or improper buffing.
7. Tires improperly retreaded, including, without limitation: Improper or inadequate inspection, preparation, equipment, material, repair, etc.
8. Ride disturbance or vibration after tread wear use beyond 10% of original usable tread depth.
9. Tires with internally applied additives for balance, sealing, cooling, or any other alleged tire performance enhancement will not void the Limited Warranty unless an inspection of the tire reveals damage related to the use of the additive.
10. Tires inflated with anything other than air or nitrogen.
11. Tires purchased or used outside of the United States.
12. The cost of applicable federal, state, and local taxes.
13. Failure to follow any of the safety and maintenance recommendations or warnings contained in this manual.

This Limited Warranty is in addition to and/or may be limited by any other applicable written warranty you may have received concerning special tires or situations.

### **No-Charge Replacement – New Tire**

Bridgestone brand truck tires adjusted under this Limited Warranty will be replaced free of charge (Federal Excise Tax included) up to the first 10% of original usable tread depth or within 12 months from date of purchase (without proof of purchase date, then within 12 months from the date of tire manufacture), whichever occurs first. The cost of mounting and balancing and other service charges, disposal fees, or applicable taxes are payable by you.

### **Pro-Rated Replacement – Worn Original Tread Tire**

Bridgestone brand truck tires adjusted under this Limited Warranty that are worn beyond the first 10% of original usable tread depth, or 12 months from the date of purchase (without proof of purchase date, then 12 months from the date of tire manufacture) has passed, the tire will, at Bridgestone’s option, be repaired or replaced with an equivalent new Bridgestone brand truck tire on a pro rata basis. To determine the replacement price, the percent of used tread wear is multiplied by the current selling price for the replacement tire(s). The cost of mounting, balancing, full Federal Excise Tax, and other service charges, disposal fees, or applicable taxes are payable by you.

### **Enhanced Casing Limited Warranty**

The Enhanced Casing Limited Warranty will apply if all the “ELIGIBILITY” requirements listed above are met and an eligible pattern, size and load range tire becomes unusable for any reason (see exclusions in the section entitled “What This Limited Warranty Does Not Cover”) within the manufacturer’s control within seven years from the date of tire manufacture and an unlimited number of retreads, the casing credit will be as follows:

Eligible Patterns: **R287A, R283 Ecopia, R283A Ecopia, R280, R268 Ecopia, R260, R250, M726EL, M720, M710 Ecopia, M760 Ecopia, M770, R195, R197, R197 Ecopia**

- Eligible Sizes & Load Ranges: 295/75R22.5, 11R22.5, 255/70R22.5, 285/75R24.5, 11R24.5 (Load Ranges G & H)

Original Tread or Retread Count	Dollar Values
Original Tread	\$130
1st Retread	\$100
2nd Retread	\$75
3rd Retread	\$50
4th & Subsequent Retreads	\$25

Eligible Pattern: **R250**

- Eligible Sizes and Load Ranges: 225/70R19.5, 245/70R19.5, 265/70R19.5 (Load Ranges G & H)

Original Tread or Retread Count	Dollar Values
Original Tread	\$100
1st Retread	\$75
2nd Retread	\$50
3rd Retread	\$25
4th & Subsequent Retreads	\$25

### **Replacement Warranty**

If you receive a replacement tire under this Limited Warranty, it will be covered by the manufacturer’s warranty, if any, given on that tire at that time.

### **Where to Go**

Tire adjustments under this Limited Warranty will only be made at an authorized Bridgestone brand truck tire retailer in the United States. Consult a phone directory (often listed in the Yellow Pages under “Tire Dealers”), the Internet at [www.trucktires.com](http://www.trucktires.com), or call 1-800-815-9793 for the location nearest you.

### **Consumer Rights**

This Limited Warranty gives you specific legal rights, and you may also have other rights which vary from state to state

### **Conditions and Exclusions**

To the extent permitted by law, Bridgestone Americas Tire Operations, LLC disclaims all other warranties, including but not limited to the implied warranties of merchantability and fitness for a particular purpose and any liability for incidental and consequential damages, loss of time, loss of vehicle use, or inconvenience. Some states do not allow the exclusion or limitation of incidental or consequential damages, so the above limitation or exclusion may not apply to you.

This Limited Warranty applies only to consumers actually purchasing and using the tire in the United States.

Obligations under this policy may not be enlarged or altered by anyone.

In accordance with Federal Law, this Limited Warranty has been designated as a “Limited Warranty.” Nothing in this Limited Warranty is intended to be a representation that tire failures cannot occur. This Limited Warranty is given in the United States by Bridgestone Americas Tire Operations, LLC, 200 4th Avenue South, Nashville, TN 37201.

## Owner's Obligations

It is your obligation to maintain proper tire inflation pressures as specified by the vehicle manufacturer and to operate the vehicle within tire/vehicle load capacity and speed limitations. It is also your obligation to maintain proper wheel alignment and tire/wheel assembly balance.

To request an adjustment, you must present the tire to an authorized Bridgestone brand truck tire retailer. Your vehicle on which the tire was equipped must also be available for inspection. Complete and sign the customer section of the Bridgestone Americas Tire Operations, LLC Limited Warranty Form or an electronic version of the Bridgestone Limited Warranty Form and pay appropriate replacement price, taxes, disposal fees, and service charges, if any. Tires accepted for warranty compensation become the property of Bridgestone Americas Tire Operations, LLC.

## Arbitration

You and Bridgestone Americas Tire Operations, LLC agree that all claims, disputes, and controversies between you and it, including any of its agents, employees, successors, or assigns, arising out of or in connection with this Limited Warranty, or any other warranties, express or implied, including a failure of warranty and the validity of this arbitration clause, but excluding claims for personal injury or property damage, shall be resolved by binding arbitration between you and it, according to the formal dispute resolution procedures of the National Arbitration Forum, under the Code of Procedure then in effect. This arbitration will be conducted as a document hearing. If you request any procedures beyond a document hearing, you will be responsible for all fees, including filing and administrative fees, above and beyond the fees required for document hearings. The arbitration between you and Bridgestone Americas Tire Operations, LLC shall not include any other customers, be combined or consolidated in any fashion with arbitrations involving other customers, or proceed in any form of class action in which the claims of numerous customers are considered together. Any award of the arbitrator(s) may be entered as a judgment in any court of competent jurisdiction. The arbitrators will have no authority to award punitive or other damages not measured by the prevailing party's actual damages, except as may be required by statute. Information may be obtained and claims may be filed at any office of the National Arbitration Forum or at P.O. Box 50191, Minneapolis, MN 55405.

## IMPORTANT SAFETY INFORMATION

Any tire, no matter how well constructed, may fail in use as a result of punctures, impact damage, improper inflation pressure, overloading, or other conditions resulting from use or misuse. Tire failure may create a risk of property damage, serious personal injury or death.

## SAFETY WARNING

Serious personal injury or death may result from a tire failure. Many tire failures are preceded by vibration, bumps, bulges or irregular wear. If a vibration occurs while driving your vehicle or you notice a bump, bulge or irregular wear, have your tires and vehicle evaluated by a qualified tire service professional.

**To reduce the risk of tire failure, Bridgestone Americas Tire Operations, LLC strongly recommends you read and follow all safety information contained in this manual, tire industry publications such as those published by the Rubber Manufacturer's Association (RMA), and tire mounting procedures published by the Occupational Safety and Health Administration (OSHA) of the U.S. Department of Labor. In addition, we recommend periodic inspection and maintenance, if necessary, by a qualified tire service professional.**

## Tire Inflation Pressure

Tires need proper inflation pressure to operate effectively and perform as intended. Tires carry the vehicle, passenger, and cargo loads and transmit the braking, acceleration, and turning forces. The vehicle manufacturer recommends the inflation pressures for the tires mounted on your vehicle.

## SAFETY WARNING

Driving on tires with improper inflation pressure is dangerous.

- Under-inflation causes excessive tire heat build-up and internal structural damage.
- Over-inflation makes it more likely for tires to be cut, punctured, or broken by sudden impact.

These situations can cause a tire failure, even at a later date, which could lead to serious personal injury or death. Consult the vehicle tire information placard and/or owner's manual for the recommended inflation pressures.

In addition to tire damage, improper inflation pressure may also:

- Adversely affect vehicle ride and handling.
- Reduce tire tread wear.
- Affect fuel economy.

Therefore, follow these important recommendations for tire and vehicle safety, mileage, and economy:

- Always keep the vehicle manufacturer's recommended inflation pressure in all your tires, including inside duals.
- Check their pressure at preventative maintenance intervals and during pre-trip vehicle inspections.

Your vehicle's tire information placard and/or owner's manual will tell you the recommended cold inflation pressure for all your tires. For tractor/trailers, a placard is applied to each. For questions about locating or understanding the tire information placard(s), consult your vehicle owner's manual or ask a qualified tire service professional.



### **Maximum Pressure Indicated on the Tire Sidewall:**

This is the maximum permissible inflation pressure for the tire only. The vehicle manufacturer's recommended tire pressures may be lower than, or the same as, the maximum pressure indicated on the tire sidewall. The vehicle manufacturer's specification of tire pressure is limited to your particular vehicle and takes into account your vehicle's load, ride, and handling characteristics, among other criteria. Since there may be several possible vehicle applications for a given tire size, a vehicle manufacturer may choose a different inflation pressure specification for that same size tire on a different vehicle. Therefore, always refer to the inflation pressure specifications on the vehicle tire information placard and/or in your vehicle owner's manual.

**Pressure Loss:** Truck tires can lose 2 psi (14 kPa) per month under normal conditions and can lose 2 psi (14 kPa) for every 10°F (5.6°C) temperature drop. A puncture, leaking valve, or other damage could also cause inflation pressure loss. If a truck tire loses more than 4 psi (28 kPa) per month, have it checked by a qualified tire service professional.

### **Tips for Safe Tire Inflation**

#### **SAFETY WARNING**

Inflating an unsecured tire is dangerous. If it bursts, it could be hurled into the air with explosive force resulting in serious personal injury or death. Never adjust the inflation pressure of a truck tire unless it is placed in a safety cage or is secured to the vehicle or a tire mounting machine. Never stand or lean over the tire or in front of the valve when inflating.

#### **SAFETY WARNING**

Never re-inflate a truck tire that has been run at very low inflation pressure (i.e. 80% or less of normal operating pressure) without a complete inspection of the entire tire. Immediately have the tire demounted and inspected by a qualified tire service professional.

- The U.S. Department of Transportation requires a pre-trip vehicle inspection. Pre-trip vehicle inspections and preventative maintenance should include cold-tire inflation pressure checks. Don't forget to check the inflation pressure of inside duals.
- The only correct method for checking inflation pressure is to use an accurate tire inflation pressure gauge. Kicking or thumping a tire will only tell you when a tire is totally flat.
- Check inflation pressure when the tires are "cold." Tires are considered "cold" when the vehicle has been parked for three hours or more, or if the vehicle has been driven less than a mile at moderate speed.
- Never release pressure from a hot tire in order to reach the recommended cold tire inflation pressure. Normal driving causes tires to run hotter and inflation pressure to

increase. If you reduce inflation pressure when your tires are hot, you may dangerously under inflate your tires.

- If it is necessary to adjust inflation pressure when your tires are "hot," set their inflation pressure to 10 psi (69 kPa) above the recommended cold inflation pressure. Recheck the inflation pressure when the tires are cold.
- If your tires lose more than 4 psi (28 kPa) per month, the tire, tube (if applicable), valve, or rim/wheel may be damaged. Consult a qualified tire service professional for an inspection.
- A difference of 5 psi (35 kPa) or more between duals is not recommended.
- Use valve caps to keep the valves clear of debris and to help guard against inflation pressure loss.

### **Tips for Safe Loading**

#### **SAFETY WARNING**

Driving your vehicle in an overloaded condition is dangerous. Overloading causes excessive tire heat build-up and internal structural damage. This can cause a tire failure, even at a later date, which could lead to serious personal injury or death. Consult the vehicle tire information placard, certification label, and owner's manual for the recommended vehicle load limits and loading recommendations.

- Always keep the vehicle manufacturer's recommended inflation pressure in all your tires, including inside duals. Check their pressure at preventative maintenance intervals and during pre-trip vehicle inspections.
- Never exceed the maximum load rating stamped on the sidewall of your tire.
- Never exceed the gross vehicle weight rating (GVWR) or gross axle weight ratings (GAWR) of your vehicle.
- Never exceed the maximum load or inflation pressure capacity of the rim/wheel.
- Consult your vehicle owner's manual for load recommendations and special instructions (such as for carrying unusually heavy loads).

### **Tire Damage & Inspection**

Evaluation and maintenance of your tires is important to their performance and the service they provide to you. Over time and/or through use, the condition of a tire can change from exposure to everyday road conditions, the environment, damaging events such as punctures, and other external factors.

#### **SAFETY WARNING**

Driving on damaged tires is dangerous. A damaged tire can suddenly fail causing serious personal injury or death. Have your tires regularly inspected by a qualified tire service professional.

You should visually inspect your tires during pre-trip vehicle inspections and inflation pressure checks. In addition, have your tires periodically evaluated by a qualified tire service professional when your vehicle is serviced such as routine maintenance intervals, oil changes, and tire rotations. In particular, note the following tips for spotting tire damage:

- After striking anything unusual in the roadway, have a qualified tire service professional demount the tire and inspect it for damage. A tire may not have visible signs of damage on the tire surface. Yet, the tire may suddenly fail without warning, a day, a week, or even months later.
- Inspect your tires for cuts, cracks, splits or bruises in the tread and sidewall areas. Bumps or bulges may indicate a separation within the tire body. Have your tire inspected by a qualified tire service professional. It may be necessary to have it removed from the rim/wheel for a complete inspection. Do not delay performing any necessary repair(s).
- Inspect your tires for adequate tread depth. When the tire is worn to the built-in indicators at 2/32 inch (1.6 mm) or less tread groove depth, or the tire cord or fabric is exposed, the tire is dangerously worn and must be replaced immediately.
- Federal regulations require steer axle tires to have 4/32 inch (3.2 mm) or greater tread depth on vehicles over 10,000 lbs (4536 kg) GVWR.
- Inspect your tires for uneven wear. Wear on one side of the tread or flat spots in the tread may indicate a problem with the tire or vehicle. Consult a qualified tire service professional.
- Inspect your rims/wheels also. If you have a bent, chipped, or cracked rim/wheel, it must be replaced.

### **Tire Manufacture Date**

The tire manufacture date is determined by examining the DOT tire identification number, also known as the DOT serial number or code, which can be found on at least one sidewall near the rim/wheel. It may be necessary to look on both sides of the tire to find the entire serial code.

**Tires Produced Since 2000:** The last four (4) digits of the serial code identify the week and year of production. For example, a tire with a serial code ending in “2406” would have been produced in the 24th week of 2006.

**Tires Produced Prior to 2000:** The last three (3) digits of the serial code identify the week and year of production. For example, a tire with a code ending in “329” would likely have been produced in the 32nd week of 1999, but possibly produced in 1989. If in doubt, consult a qualified tire service professional.

## **Tire Repairs**

### **SAFETY WARNING**

Driving on an improperly repaired tire is dangerous. An improper repair can be unreliable or permit further damage to the tire. The tire may suddenly fail, causing serious personal injury or death. A complete inspection and repair of your tire in accordance with Rubber Manufacturers Association (RMA) procedures should be conducted by a qualified tire service professional.

The comprehensive procedures and recommendations for truck tire repair are beyond the scope of this manual; however, note the following:

- **The tire must be demounted from the rim/wheel for a complete inspection, inside and out.** Some damage to the tire may only be evident on the interior of the tire. Any tire repair done without removing the tire from the rim/wheel is improper.
- **A patch must be applied to the interior of the tire and the puncture hole filled with suitable plug/stem filler.** This helps ensure that the interior of the tire is adequately sealed to prevent inflation pressure loss and prevents contamination of the steel belts and other plies from the elements (such as water) in the outside world. Using only a plug/stem, or using only a patch, is not a safe or proper repair.
- **The truck/bus tire puncture repair injury limit to the tread area is 3/8 inch (10 mm).** Larger injuries, or damage in areas outside the tread, should be evaluated and repaired, if possible, by qualified tire service professionals at a full-service repair facility using RMA-approved procedures.
- **Never substitute a tube for a proper repair or to remedy an improper repair.**
- **Not all punctured or damaged tires can be properly repaired;** consequently, they must be replaced.
- **Repair and retread, if possible, tires having a tread depth of 2/32 inch (1.6 mm) or less remaining in any tread groove.**
- **Tubes, like tires, should only be repaired by a qualified tire service professional.**
- **Any Improper repair voids the tire Limited Warranty.** See “Limited Warranty” in this manual.

# Removing Tire/Wheel Assembly from Vehicle

## **SAFETY WARNING**

Always follow the manufacturer's recommend procedure for securing and raising your vehicle prior to attempting to remove a tire.

## **SAFETY WARNING**

If the tire has internal damage, it may burst with explosive force, causing serious personal injury or death. Always deflate a tire and wheel assembly completely before loosening any lug nut when removing a tire from a vehicle for service or demounting. On dual wheel assemblies, both tires should be deflated and removed before any work is started.

# Tire Mounting & Other Servicing

## **SAFETY WARNING**

Removing and replacing tires on wheels can be dangerous. Attempting to mount tires with improper tools or procedures may result in a tire explosion causing serious personal injury or death. This is only a job for a qualified tire service professional. Never perform tire service procedures without proper training, tools, and equipment.

**This manual is not intended to provide proper training or service procedures for tire mounting, demounting, balancing, rotation, or repair. Please leave these tasks to qualified tire service professionals.**

Only specially trained persons should mount tires. For proper mounting procedures, consult the requirements of the Occupational Safety and Health Administration (OSHA) of the U.S. Department of Labor and procedures published by the Rubber Manufacturers Association, 1400 K Street, NW Washington, DC 20005 ([www.rma.org](http://www.rma.org)).

## **SAFETY WARNING**

Inflating an unsecured tire is dangerous. If it bursts, it could be hurled into the air with explosive force resulting in serious personal injury or death.

- Always stand well clear of any tire mounting operation. This is especially important when the service operator inflates the tire.
- When inflating a tire after mounting on a rim/wheel, always use a safety cage and an extension hose with pressure gauge and clip-on chuck.
- Never adjust the inflation pressure of a truck tire unless it is placed in a safety cage or is secured to the vehicle or a tire mounting machine.
- Never stand or lean over the tire or in front of the valve when inflating.

## **SAFETY WARNING**

Never pour or spray any flammable substance into or onto a tire or rim/wheel for any purpose whatsoever. The residue left by the substance could result in a fire or explosion which may cause severe injury or death.

## **SAFETY WARNING**

Never put flammable substances such as gasoline or ethyl ether into a tire and light with a match/flame so that the resulting explosion seats the beads of a tubeless tire. This practice is extremely dangerous and may result in a severe explosion or undetected damage to the tire or rim/wheel which may cause a failure resulting in severe injury or death.

- **Tires must match the width and diameter requirements of the wheels.** For example, 22.5 inch diameter tires must only be mounted to 22.5 inch diameter rims/wheels. Radial tires must only be mounted to wheels approved for radial tires.
- **Inspect the tire and rim/wheel.** Rims/wheels must be free of cracks, dents, chips, and rust. Tires must be free of bead damage, cuts, punctures, foreign material, and moisture.
- **For a tubeless truck tire, always install a new valve, or new valve core and cap,** each time a new or retreaded tire is installed.
- **For a tube-type truck tire, always use a new, proper size tube and flap** each time a new or re-treaded tire is installed.
- **Use only vegetable oil-based lubricants in mounting or demounting.**
- **Always ensure rim components fit properly before inflating.**
  - Never tap component parts with a tool/hammer/mallet while tire is inflated.
  - Never attempt to disassemble multi-piece rims while inflated.
- **Never inflate a tire beyond 40 psi (275 kPa) to seat the beads.** Be absolutely certain beads are fully seated before adjusting inflation pressure to the level recommended for vehicle operation.
- **Use valve caps** to keep the valves clear of debris and to help guard against inflation pressure loss.
- **Always stand well away from the work area** when tires are being spin-balanced either on or off the vehicle.

## Tire Mixing

### **SAFETY WARNING**

Driving your vehicle with an improper mix of tires is dangerous. Your vehicle's handling characteristics can be seriously affected. You could have an accident resulting in serious personal injury or death. Consult your vehicle owner's manual and a qualified tire service professional for proper tire replacement.

## Dual Matching

Tires paired in a dual assembly should be matched in tire construction and dimension. Improperly matched tires may result in irregular wear, rapid wear, and premature tire failure. Failure to match tires in a dual assembly may result in sudden tire destruction.

For radial tires, properly paired dimension tolerances are as follows:

- Diameter: within 1/4 inch (6.4 mm) of each other
- Circumference: within 3/4 inch (19 mm) of each other

## High Speed Driving

### **SAFETY WARNING**

Driving at high speed is dangerous and can cause a vehicle accident, including serious personal injury or death.

- Regardless of the speed and handling capabilities of your vehicle and its tires, a loss of vehicle control can result from exceeding the maximum speed allowed by law or warranted by traffic, weather, vehicle, or road conditions.
- High-speed driving should be left to trained professionals operating under controlled conditions.
- No tire, regardless of its design or speed rating, has unlimited capacity for speed, and a sudden tire failure can occur if its limits are exceeded. See "Tire Speed Restrictions," the next section in this manual.

Refer to your vehicle owner's manual for any tire pressure recommendations for high speed driving.

## Tire Speed Restrictions

Bridgestone brand truck tires have maximum recommended speeds. When replacing your tires, check your vehicle owner's manual and tire information placard and consult with a Bridgestone brand truck tire retailer for recommendations and information about tire speed capability.

The speed capabilities of truck tires are based on standardized laboratory tests under specific, controlled conditions. While these tests may relate to performance on the road, real-world driving is rarely identical to any test conditions. Your tire's actual speed capability may be less since it is affected by factors such as inflation pressure, load, tire condition (including damage), wear, vehicle condition (including alignment), driving conditions, and duration at which the speed is sustained.

## Tire Spinning

### **SAFETY WARNING**

Spinning a tire to remove a vehicle stuck in mud, ice, snow, or wet grass can be dangerous. A tire spinning at a speedometer reading above 35 mph (55 km/h) can in a matter of seconds reach a speed capable of disintegrating a tire with explosive force. Under some conditions, a tire may be spinning at a speed twice that shown on the speedometer. This could cause serious personal injury or death to a bystander or passenger. Never spin a tire above a speedometer reading of 35 mph (55 km/h).

## Tire Storage

Tires should be stored indoors in a cool, dry place where water cannot collect inside them. Tires should be placed away from electric generators/motors and sources of heat such as hot pipes. Storage surfaces should be clean and free of grease, gasoline, diesel fuel, or other substances which can deteriorate the rubber.

### **SAFETY WARNING**

Improper storage can damage your tires in ways that may not be visible and can lead to a failure resulting in serious personal injury or death.

The spare tire in your vehicle is intended to be used as a spare when needed. The spare tire carrier is not intended to be used for long term storage.

## Tire Service Customer Satisfaction

Normal tire maintenance and Limited Warranty services are available at locations across the U.S.A. Visit us at [www.bridgestonetrucktires.com](http://www.bridgestonetrucktires.com), or call 1-800-815-9793 to find an authorized Bridgestone brand truck tire retailer nearest you.

Additional information on the care and service of truck tires is available from the following organizations:

### US Tire Manufacturers Association

1400 K Street, N.W.  
Washington, DC 20005-2403  
[www.USTires.org](http://www.USTires.org)

### Rubber Association of Canada

2000 Argentia Road, Plaza 4, Suite 250  
Mississauga, Ontario L5N 1W1  
[www.rubberassociation.ca](http://www.rubberassociation.ca)

## Tire Registration

Registration of your tires is an important safety precaution since it enables the manufacturer to notify you in the event of a recall. When you purchase replacement tires, the retailer will provide a registration card on which the tire identification numbers have been recorded; fill in your name and address on the card and mail it promptly. Some retailers may submit the registration for you. You do not need to register original equipment tires on new vehicles as the vehicle manufacturer handles that for you.

### ***For Assistance or Information:***

1. First contact the nearest Bridgestone truck tire Dealer by call 1-800-815-9793 or use our Dealer locator at [www.notifyben.com](http://www.notifyben.com)
2. If additional assistance is required, call or write the nearest Bridgestone Technical Service Center listed below.

### **Bridgestone Toll-Free Number**

1-800-847-3272

Bridgestone Americas Tire Operations, LLC  
200 4th Avenue South, Nashville, TN 37201  
(615) 937-1000

## Technical Service Centers

### WEST REGION

2500 S. Doubleday • Ontario, CA 91761

### Central Region

2100 Internationale Pkwy • Woodridge, IL 60517

### EAST REGION

201 Bridgestone Pkwy • Lebanon, TN 37090

## Commercial Tire Tubes, Valves & Flaps

### Medium Tire

TIRE SIZE	TUBE	VALVE	FLAP
11.00R24	11.00/12.00R24	TR444	24R8
12.00R24	11.00/12.00R24	TR444	24R9

### Light Truck

TUBE SIZE	MATERIAL NUMBER	DESCRIPTION
6.00/7.00R15	539-155	TR150 W
7.50R16	539-147	TR150 CW
7.50R16	539-163	TR177A Steel Valve 20mm offset
7.50R16	938-068	FLAP 20mm offset

## Radial & Bias Tire Construction



**Radial**



**Bias/Diagonal**

Radial tire body ply cords are placed straight across the tire from bead to bead. In addition, radial tires have belt plies, which run circumferentially around the tires, under the tread. They constrict the radial ply cords and stabilize the tread area.

Bias/Diagonal tires have multiple layers of plies with the cords in adjacent plies running in alternate diagonal directions from bead to bead. The tires may also have narrow plies under the tread, called breakers, with cords that lie in approximately the same direction as the body ply cords.

The type of construction can be determined by looking at the size designation molded on the tire's sidewall. Radial truck tire sizes have an "R" in the size designation while bias/diagonal truck tire sizes have a hyphen in the size description. For example, a 10.00R20 tire is a radial, while a 10.00-20 tire is a non-radial.

In addition, ALL radial tires have the word "RADIAL" molded onto the sidewall. All radial truck tires also use an "R" in the size designation, e.g., 285/75R24.5.

## Definitions

### Truck Tire Size Designation

**10.00 R 20 14 (G)**

Nominal Section Width in Inches (Conventional)

Radial Construction

Tube Type Rim Diameter in Inches (5° Tapered Bead)

Ply Rating

Load Range

**11 R 22.5 14 (G)**

Nominal Section Width in Inches (Conventional)

Radial Construction

Tubeless Rim Diameter in Inches (15° Tapered Bead)

Ply Rating

Load Range

Nominal Section Width  
in Millimeters (Metric)

**A 285/75 R 24.5 14 (G)**

Aspect Ratio

Radial Construction

Tubeless Rim Diameter in Inches (15° Tapered Bead)

Ply Rating

Load Range

see page 69

see page 72

see page 72

Nominal Section Width  
in Millimeters (Metric)

**315/80 R 22.5 20 (L)**

Aspect Ratio

Radial Construction

Tubeless Rim Diameter in Inches (15° Tapered Bead)

Ply Rating

Load Range

Nominal Section Width  
in Millimeters (Metric)

**445/50 R 22.5 20 (L)**

Aspect Ratio

Radial Construction

Tubeless Rim Diameter in Inches (15° Tapered Bead)

Ply Rating

Load Range

# Truck Tire Dimensions

## A. (Nominal) Section Width

Measurement of the cross section of an unladen tire across the casing only – not including ribs or protrusions.

## A. Overall Width

Measurement of the cross section of an unladen tire, including ribs and protrusions. Usually the same as section width on radial tires.

## B. Section Height

Distance from the bead seat to the tread surface of an unladen tire.

## C. Aspect Ratio

$$\text{Aspect Ratio} = \frac{\text{Section Height}}{\text{Section Width}}$$

## D. Tread Width

Distance across the tread face of an unladen tire.

## E. Tread Depth

Distance from tread surface to major groove base at designated measuring point.

## F. Loaded Width

The maximum section width of a loaded tire under maximum dual load and inflation as stamped on the sidewall of the tire.

## G. Overall Diameter

The measurement of the distance of an unladen tire from tread surface to tread surface on opposite sides of the tire.

## H. Static Loaded Radius

Distance from the center of the axle to the ground of a loaded tire under maximum dual load and inflation as stamped on the sidewall of the tire.

## I. Rim Width

Distance between the rim flanges.

## J. Nominal Rim Diameter

Diameter of the rim from bead seat to bead seat in inches.

## Minimum Dual Spacing

The minimum allowable distance between the wheel center lines in a dual arrangement.

## Revolutions Per Mile (RPM)

The number of tire revolutions in one mile, measured at 55 mph maximum dual load and inflation (as stamped on the tire's sidewall).

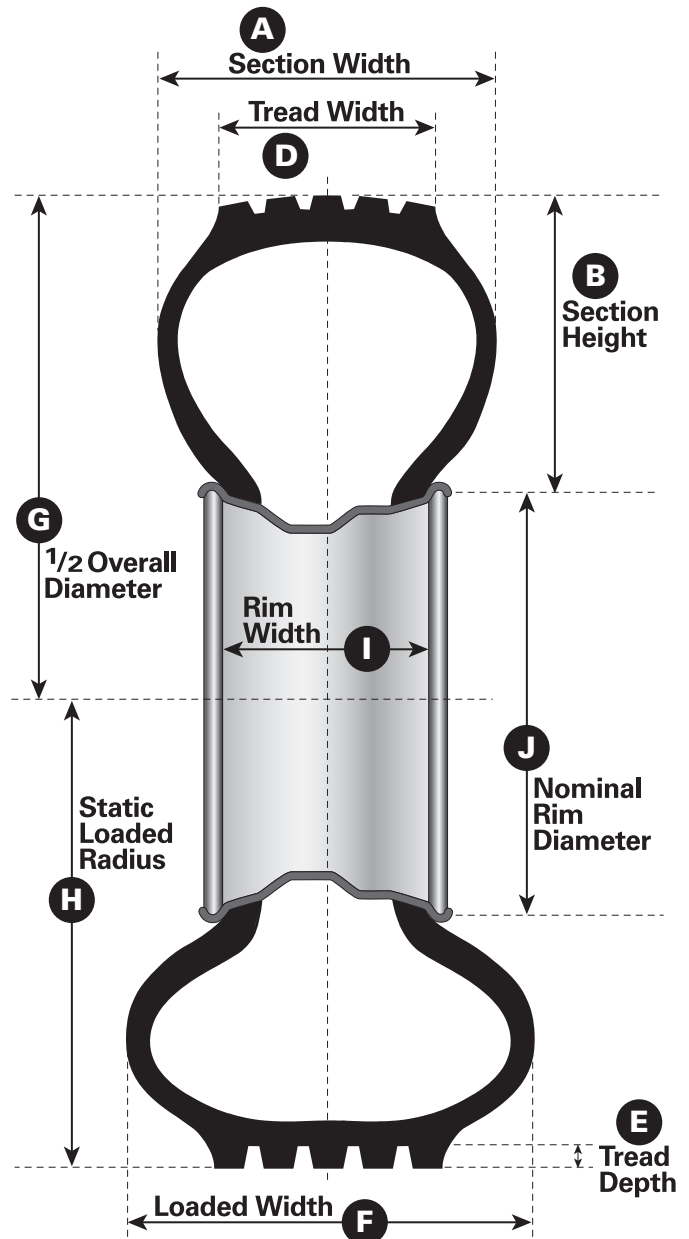

**NOTE: Tires mounted and inflated to recommended pressure. All dimensions measured 24-hours after initial inflation.**



## Ply Rating/Load Range

PLY RATING	LOAD RANGE
2	A
4	B
6	C
8	D
10	E
12	F
14	G
16	H
18	J
20	L
22	M

While there is no industry-wide definition of ply rating, truck tires are frequently marked with ply rating and equivalent load range. These markings are used to identify the load and inflation limits of that particular tire, when used in a specific type of service. See adjacent table for conversion of tire markings. Corresponding loads may be found in appropriate load tables.

## Speed Symbol

SPEED SYMBOL	SPEED CATEGORY (KM/H)	MPH
F	80	50
G	90	55
J	100	62
K	110	68
L	120	75
M	130	81
N	140	87

The SPEED SYMBOL indicates the speed at which the tire can carry a load corresponding to its Load Index under service conditions specified by the tire manufacturer.

## International Load Index Numbers

LOAD INDEX	KGS	LBS	LOAD INDEX	KGS	LBS	LOAD INDEX	KGS	LBS	LOAD INDEX	KGS	LBS	LOAD INDEX	KGS	LBS	LOAD INDEX	KGS	LBS
90	600	1325	104	900	1985	118	1320	2910	132	2000	4410	146	3000	6610	160	4500	9920
91	615	1355	105	925	2040	119	1360	3000	133	2060	4540	147	3075	6780	161	4625	10200
92	630	1390	106	950	2095	120	1400	3085	134	2120	4675	148	3150	6940	162	4750	10500
93	650	1435	107	975	2150	121	1450	3195	135	2180	4805	149	3250	7160	163	4875	10700
94	670	1475	108	1000	2205	122	1500	3305	136	2240	4940	150	3350	7390	164	5000	11000
95	690	1520	109	1030	2270	123	1550	3415	137	2300	5070	151	3450	7610	165	5150	11400
96	710	1565	110	1060	2335	124	1600	3525	138	2360	5205	152	3550	7830	166	5300	11700
97	730	1610	111	1090	2405	125	1650	3640	139	2430	5355	153	3650	8050	167	5450	12000
98	750	1655	112	1120	2470	126	1700	3750	140	2500	5510	154	3750	8270	168	5600	12300
99	775	1710	113	1150	2535	127	1750	3860	141	2575	5675	155	3875	8540	169	5800	12800
100	800	1765	114	1180	2600	128	1800	3970	142	2650	5840	156	4000	8820	170	6000	13200
101	825	1820	115	1215	2680	129	1850	4080	143	2725	6005	157	4125	9090			
102	850	1875	116	1250	2755	130	1900	4190	144	2800	6175	158	4250	9370			
103	875	1930	117	1285	2835	131	1950	4300	145	2900	6395	159	4375	9650			

Selection of Load Index Numbers: Select the load index number with the equivalent load of the tire (round up to midpoint). If the tire maximum load rating is only given in customary units, convert that load to kilograms and select the closest load index equivalent (Kg) load.

# Inflation Pressure

For optimum tire performance, proper inflation pressures for the loads being carried must be maintained. The proper inflation pressure can be found in the load and inflation tables of this book.

Air pressure of all tires should be checked and corrected weekly with an accurate inflation pressure gauge. Since air expands when heated, tire pressures will increase due to the normal build-up of heat during operation. For this reason, tire pressures should be checked while cold. Do not bleed air from tires while hot. This will result in an under-inflated condition.

Under-inflated tires build up excessive heat due to over-deflection and may result in tire deterioration. Operating on an improperly inflated tire will cause severe tire damage.

The inflation pressures given are the minimum pressures for the associated load. Do not exceed the maximum loads listed in this book without consulting a Bridgestone Technical Representative. Any tire known or suspected to have been run at 80% or less of normal operating inflation pressure and/or overloading could possibly have permanent structural damage (steel cord fatigue).

# Tire Mixing

Tires of different sizes or construction must never be mixed on the same axle.

Tires of different construction can be mixed in the following manner:

**A) TRUCKS WITH TWO AXLES, FOUR WHEELS:**  
Radials can be mixed with bias ply tires providing the radials are mounted in pairs on the rear axle.

**B) TRUCKS WITH TWO AXLES, SIX WHEELS:**  
(e.g. single axle tractors) Radials can be mixed with bias ply tires providing tires of the same construction are mounted on the same axle.

**C) TRUCKS WITH MORE THAN TWO AXLES:**  
(e.g., tandem axle tractors) The front tires may be bias or radial and can be run with bias or radial on the drive axles. Trucks with multiple drive axles

should have tires of the same construction mounted on all drive positions.

**D) TRAILERS:**

Bias or radial tires may be used, providing tires on the same axle are of the same construction. Tires of different construction must not be used in dual fitments. Tubeless tires can be mixed with tube-type tires, providing they are of equivalent sizes.

**E) WIDE BASE & DUALS:**

Wide base and duals can be mounted together as long as overall diameter is within 1/4 inch.

# Dual Matching

Tires in dual assemblies should be matched with regard to design and dimensional tolerances as noted below.

Improperly matched duals may result in irregular wear, rapid wear, vehicle mechanical problems and premature tire failure. Failure to match tires in a dual assembly may result in sudden tire destruction.

## DUAL MATCHING LIMITS

TIRE CONSTRUCTION	DIAMETER	CIRCUMFERENCE
Radial	0 to 1/4 inch	0 to 3/4 inch

## Mismatched Duals

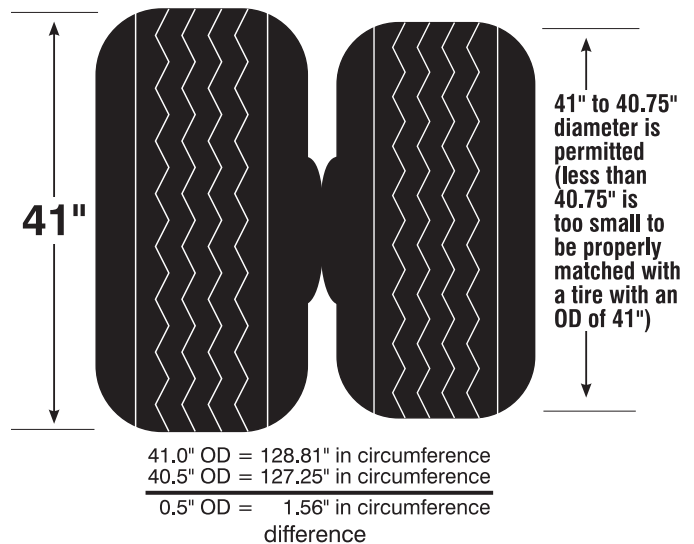

# Medium Truck Approved Rim Width & Minimum Dual Spacing

TIRE SIZE	APPROVED RIM WIDTH	MIN. DUAL SPACING
<b>TUBE TYPE</b>		
11.00R24	8.5, 8.50VM, <b>8.0</b> , 7.5	13.2
12.00R24	9.0, <b>8.5</b> , 8.50VM, 8.0	14.1
<b>TUBELESS</b>		
9R17.5HC	<b>6.75HC</b>	10.3
8R19.5	5.25, <b>6.00</b> , 6.00RW, 6.75, 6.75RW	9.1
9R22.5	6.00, <b>6.75</b> , 7.50	10.3
10R22.5	6.75, <b>7.50</b> , 8.25	11.4
11R22.5	7.50, <b>8.25</b>	12.5
12R22.5	8.25, <b>9.00</b>	13.5
11R24.5	7.50, <b>8.25</b>	12.5
12R24.5	8.25, <b>9.00</b>	13.5
215/75R17.5	<b>6.00HC</b> , 6.75HC	9.3
245/70R17.5	<b>6.75</b> , 7.50	10.6
225/70R19.5	6.00, 6.00RW, <b>6.75</b> , 6.75RW	10.0
245/70R19.5	6.75, 6.75RW, <b>7.50</b> , 7.50RW	11.0
265/70R19.5	<b>7.50</b> , 7.50RW, 8.25, 8.25RW	11.6
285/70R19.5	7.50, <b>8.25</b> , 9.00	12.5
305/70R19.5	<b>9.00</b> , 8.25, 8.25RW	13.5
445/65R19.5	<b>13.00</b> , 14.00	NA
245/75R22.5	6.75, <b>7.50</b>	11.0
255/70R22.5	<b>7.50</b> , 8.25	11.3
265/75R22.5	<b>7.50</b> , 8.25	11.6
275/70R22.5	7.50, <b>8.25</b> , 9.00	12.2
295/60R22.5	<b>9.00</b> , 9.75	13.0
295/75R22.5	8.25, <b>9.00</b>	13.2
295/80R22.5	8.25, <b>9.00</b>	13.2
305/70R22.5	8.25, <b>9.00</b>	13.8
315/80R22.5 †	8.25, <b>9.00</b> , 9.75	13.8
385/65R22.5	<b>11.75</b> , 12.25	NA
425/65R22.5	11.75*, <b>12.25</b> , 13.00, 14.00	NA
445/50R22.5	<b>14.00</b>	NA
445/65R22.5	12.25*, <b>13.00</b> , 14.00	NA
455/55R22.5	<b>14.00</b>	NA
285/75R24.5	<b>8.25</b>	12.5

**Minimum Dual Spacing** is listed for the design rim width. If design rim not used Minimum Dual Spacing must be adjusted per note 1 (below) for other rim widths.

**Design Rim Width** shown in boldface type.

† 8.25-rim may be used if tire load is limited to 8,000 lbs. single and 7,610 lbs. dual @ 130 psi. Note: The minimum dual spacing for 8.25-rim is 13.2". Do not exceed manufacturer's recommended maximum load and inflation.

Note 1: New tire section widths and overall widths will change 0.10-inches for each 0.25-inch change in rim width.

Note 2: Use alternate rims only when recommended rims cannot be used.

Note 3: Do not use different rim widths in dual applications.

\* This rim size maybe phased out in the future for this tire size.

## Tire Rotation

Tire rotation is a practical means of reducing tire costs when irregular or rapid wear are prevalent. Rotation patterns, such as those recommended by vehicle manufacturers, may be followed. There are no restrictions on criss-cross rotation. Tires having directional type tread patterns should be mounted in the recommended direction of rotation for optimum performance.

For many directional type designs it is permissible to change the direction of rotation after the first  $\frac{3}{32}$ " -  $\frac{5}{32}$ " of tread wear. Contact tire manufacturer for pattern-specific recommendation. The casing, after retreading, may be run in either direction, as the casing is not directional.

## Regrooving

Regroove only those tires marked "Regroovable" on the sidewall. Tires with a remaining tread depth of less than  $\frac{2}{32}$ " should not be regrooved. It is recommended that tires exhibiting severe irregular wear not be regrooved. Regrooved tires should not be placed on the front axle.

Regrooving should be restricted to the tire's original tread grooves. A minimum rubber gauge of  $\frac{4}{32}$ " must be maintained between the tire's top belt and the re-grooved grooves.

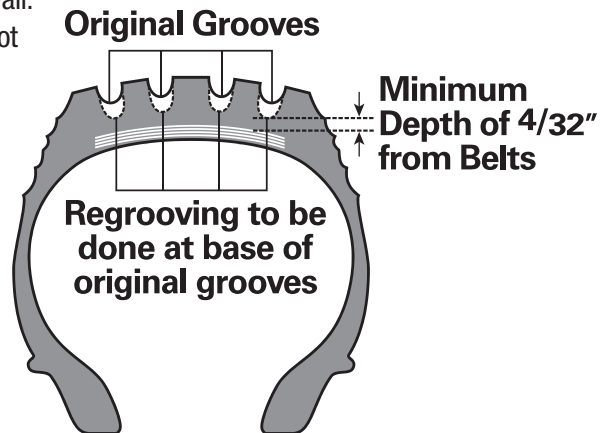

## Branding

The location for branding must be chosen carefully due to the thin sidewall gauge. Many sidewalls have branding panels, or designated branding areas as noted in sketch at left. Branding in the wrong location may result in eventual tire failure. It is recommended that the brand be located between the rim line and size panel.

Branding depth should be  $\frac{1}{32}$ ". Do not brand deeper than  $\frac{2}{32}$ ".

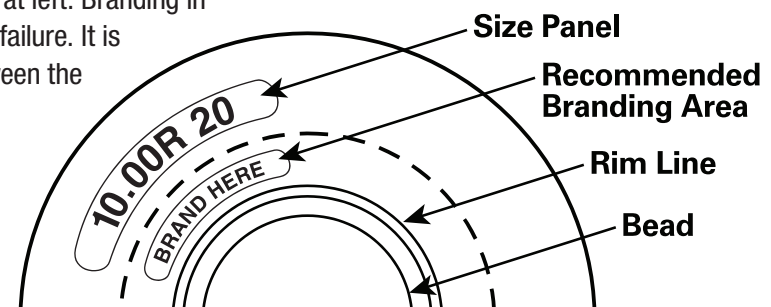

*Proper Branding Area on Steel Radial Tire*

# Wheel Alignment

## Toe-In

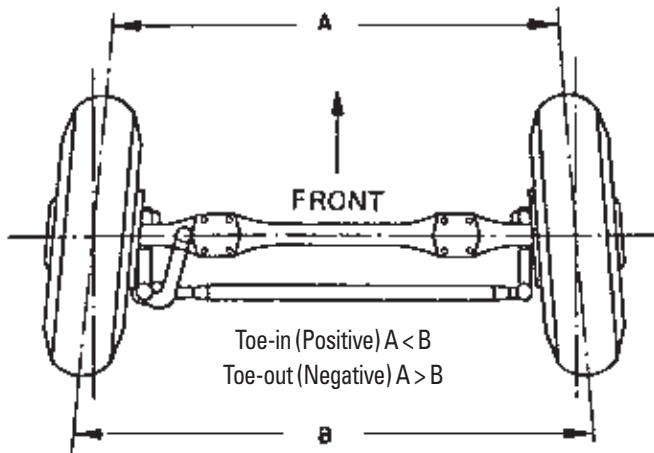

Proper wheel alignment is essential for optimum tire life and vehicle handling characteristics. **Alignment settings should be checked with the truck loaded.** Alignment adjustments can be made on an unloaded truck; however, modifications in the vehicle manufacturer's alignment recommendations may be required for proper "loaded" settings.

### Front Axle Recommendations

- **Toe-in:** set as close to zero as vehicle manufacturer's recommendations allow in loaded condition. Do not set beyond zero, as a toe-out condition will develop.
- **Caster:** set to the maximum positive setting which the vehicle manufacturer's recommendations will allow.
- **Camber:** set as close to zero degrees as the vehicle manufacturer's recommendations allow in loaded condition.

## Caster

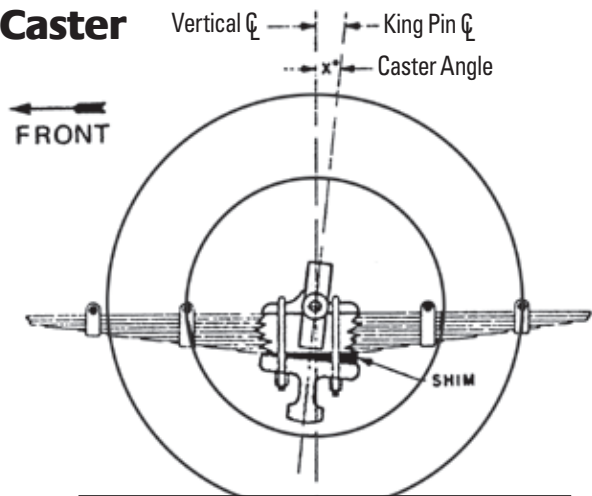

### Drive Axle Recommendations

Misalignment of the drive axles may also cause rapid or irregular wear on the front axle as well as the drive axle due to constant steering correction. Drive axle alignment should be corrected before front axle settings are made.

Drive axles should be aligned in the following manner:

1. Position drive axles perpendicular to the chassis centerline.
2. For tandem drives, the drive axles should be positioned parallel to one another.

## Camber

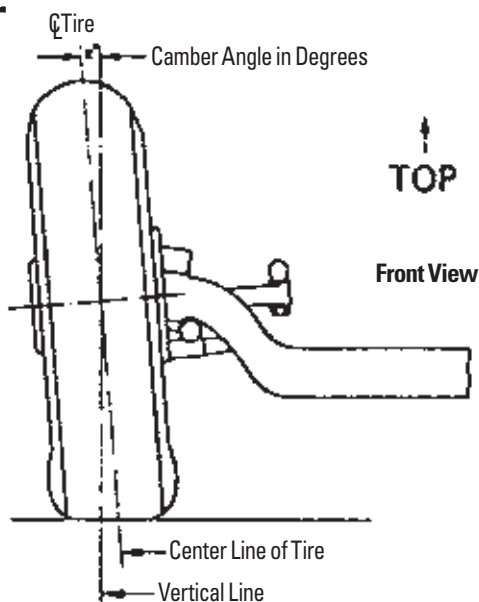

If they are not parallel, the condition is referred to as "tandem scrub." Our recommendation is the distance between the axle centers is set so the distance on the right is equal to or greater than the distance on the left by up to 1/8" (.125").

The distance on the axle centers on the right should never be shorter than the distance on the left. The wear pattern that will result from this situation is inside left front/outside right front shoulder wear.

# Balance/Runout

Tire and wheel imbalance may result in irregular tire wear. Steering axle and drive axle tires should be balanced dynamically for best results. Vibration may also be the result of mismatch of the high and low spots of the tire and wheel.

To resolve vibration problems, the runout of tire and rim should be measured, then matched in the following manner:

1. With the tire mounted on the rim, number both at 12 asymmetrical points.
2. Measure runout at both shoulders of the tire (inside & outside) and record the results. (Note: accuracy in these measurements is essential.)
3. Demount the tire, measure both sides of the rim for runout, record the results, then average the inside and outside measurements.
4. Matching the lowest average point of the rim to the highest average point of the tire, remount the tire, then balance accurately.
5. It may be necessary to repeat this procedure since the tire cannot be measured accurately while on an imperfect rim.

Note: If a runout dial is not available, rotate the tire 180° relative to the rim and remount. If the vibration persists, rotate the tire another 90°, then another 180°.

6. The maximum suggested radial runout for a rotating tire/wheel assembly is 0.095 inches for both front and rear tire positions. If runout exceeds these limits, check for bent rims, cocked rims, improperly adjusted wheel bearings, improper tire bead seating, tire flat spots, improperly tightened rim clamps and rear rim spacers.

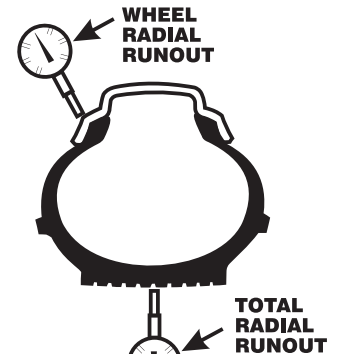
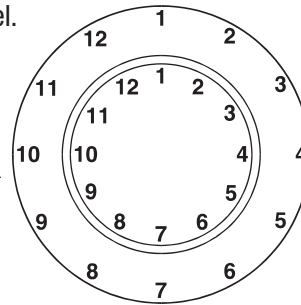

**Proper Position for Measuring Runout**

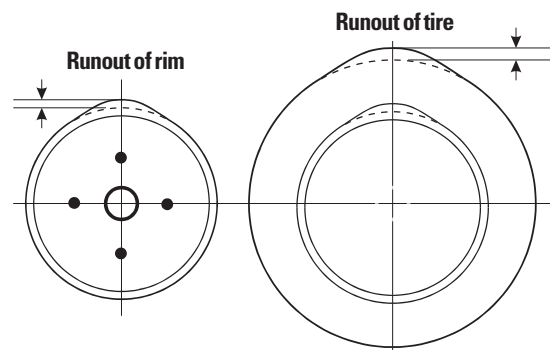

**Runout of Tire Due to Runout of Rim**

## Special procedure for improving steering tire run-out on vehicles with hub-piloted wheels

If you suspect high run-out on the steering position and have hub-piloted wheels, use the following procedure to improve the radial run-out.

1. Measure the radial run-out of the tire/wheel assemblies on the vehicle's steering position. Mark the highest and lowest points of the radial run-out on the tire with chalk or other marker.
2. Remove the tire/wheel assembly and position the hub so that the gap between any two of the hub pilot pads is at 12:00. With the hub in this position place the tire/wheel assembly on the hub so that the high point mark is at the top (12:00). Carefully tighten one nut with a hand wrench until it is snug enough to hold the wheel securely. Reposition the wheel on the hub pilot pads while tightening.

(Don't use an air wrench to tighten the first nut. It will reposition the wheel and not let gravity keep the wheel in contact with the hub pads that are at the top). After the first nut is tightened with the hand wrench, tighten all nuts according to sequence and procedure shown in **TMC RP 222, User's Guide to Wheels and Rims**.

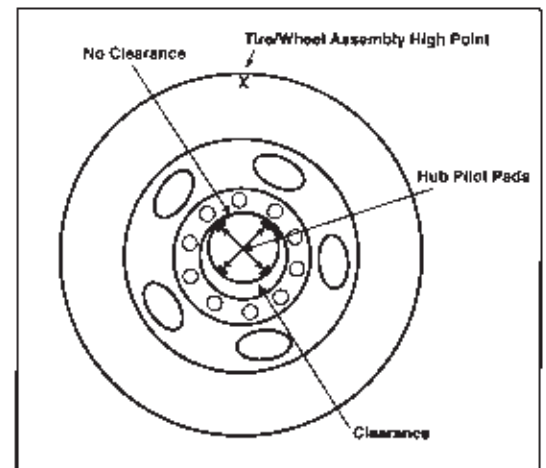

Figure 7

continues >>

If you have followed this procedure correctly, you will find there is clearance between the hub pads and the wheel pilot hole at the bottom and no clearance at the top (See Figure 7.) shown on previous page.

3. Recheck the radial runout to verify that it has been improved. By locating the high point, repositioning the wheel, putting the high point at the top and re-tightening, gravity should have put the wheel in a better position with

respect to the hub. Improvements up to .020" are common and can greatly improve the ride.

[ Information reprinted with permission from: **RP 214B, Tire/Wheel Balance and Runout**, in **TMC's Recommended Practices Manual**, published by the Technology & Maintenance Council (TMC) of American Trucking Associations, 2200 Mill Road, Alexandria, VA 22314; (703) 838-1763. [tmc.truckline.com](http://tmc.truckline.com) ]

## Tire Mounting For Low Vibration

### Special Low Vibration Mounting For Bridgestone Radial Truck Tires

All Bridgestone tires have yellow marks, to aid in initial balance. (White marks are factory inspection marks, and are not used in mounting or balancing).

Proper use of these marks during new tire mounting and installation can result in a better ride and less vehicle vibration.

Place the yellow mark next to the valve stem, regardless of wheel type. Torque wheel nuts with the yellow mark at the "12 o'clock" position.

On dual assemblies, regardless of tire marks, install tires on axles with valve stems approximately 180 degrees apart.



Tire light static balance mark (Yellow)

Valve stem, on aluminum rims or steel rims



Valve stems

## Mounting Radial Truck Tires to Help Reduce Vibration & Irregular Wear

Consistent, correct truck tire mounting is important for proper bead-to-wheel fit, and can help reduce vehicle vibration and irregular wear for better ride and longer original tread life.

Important steps:

1. Clean and paint used wheels.
2. Lubricate both tire beads and both wheel seats.
3. Check the assembly for even centering.

**Always follow all OSHA, RMA and manufacturer's tire mounting safety precautions!**

*(See Section on Mounting/Demounting Procedures in this data book.)*



1. Remove dirt, rust or corrosion that can interfere with proper seal or damage bead.



5. Inflate assembly to set bead and check for leaks around the wheel.



2. Protect bare metal with primer or anti-rust paint to prevent further corrosion. Allow to dry.



6. Measure distance from molded ring on tire to flange locations, 90 degrees apart.



3. Lubricate the wheel bead seat using vegetable oil-based lubricant approved for both tire and wheel.

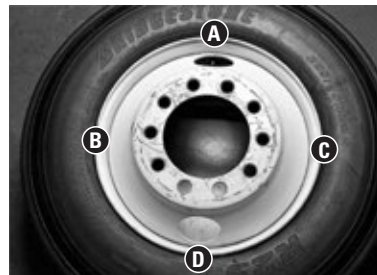

7. Distances A, B, C, and D should be within  $2/32$ ". If they are not, break down, re-lubricate and mount again.



4. Lubricate tire bead. Do not use petroleum or solvent-based products. They cause rubber to deteriorate.



## Storage

All tires should be stored in accordance with the following recommendations:

1. Avoid storing tires in direct sunlight.
2. Avoid storing tires near a heat source or in the path of a direct flow of forced air.
3. Keep tires away from electric motors and generators which produce ozone.
4. Do not store near petroleum products or chemicals (such as oil, grease, gasoline, solvent, etc.).
5. Limit vertical stacking to a maximum of 5 feet in height.
6. Store un-mounted tires indoors in a dry location. Steel radial tires may be severely damaged due to the presence of moisture inside the tire at mounting. Upon pressurization, this moisture can permeate the casing of the tire and cause severe deterioration of the steel cords.
7. Prior to mounting, inspect the inside surfaces of the tire and remove all foreign material and moisture.
8. Keep compressed air sources for tire inflation free of moisture.

**Failure to follow the above recommendations could result in sudden tire failure, property damage and personal injury.**

## Tire Inspection

Prior to operating a vehicle, an inspection should be made of each tire, including the spare. Examine tires for cuts, bruises, cracks, bulges and penetrations. If any damage is found, have the tire examined by a Bridgestone dealer. Repair of tire damage must be made as soon as possible in order to avoid further deterioration of the tire structure.

Federal law requires that front axle truck tires on vehicles over 10,000 lbs. gross vehicle weight must have at least 4/32" tread depth. Tread wear indicators are contained in the tread of Bridgestone truck tires and become visible when the tread depth reaches 2/32" in two adjacent major grooves.

Drive and trailer tires should be replaced when the tread depth reaches 2/32" or the wear bars appear since 2/32" is the minimum permissible legal tread depth on all axles except the front.

Tires should also be inspected prior to mounting on a rim. Bridgestone steel radial tube-type truck tires are shipped with the flap in the tire. It is essential that the tire be disassembled and inspected thoroughly prior to mounting to insure the inside surfaces are completely dry and clean.

Water in casings of steel radial tires may cause tire failure. During normal operation, heat build-up inside the tire will turn water into vapor which may permeate the inner-liner and enter the steel casing cord, causing rust, deterioration, possible sudden tire failure, property damage and/or personal injury.

	DOT Legal Limits
Steering Axle	4/32"
Drive Axle	2/32"
Trailer Axle	2/32"

# Irregular Wear of Radial Truck Tire

There are many factors that may trigger the occurrence of irregular wear. Among those, mechanical malfunctions of vehicles such as misalignment and uniformity of the tire and wheel assembly are the major factors. If, after correction of these problems is made, objectionable irregular wear is still observed, Bridgestone recommends the following steps be taken:

**Steer-axle tires:** Check thrust angle & apply higher inflation pressure within permissible range (100–115 psi).

**Drive-axle tires:** An increase of 10-15 psi makes the tire less susceptible to irregular wear. Forward movement of the fifth wheel within permissible range greatly reduces irregular wear.

## Low Profile Tires

Low profile 75-series tubeless truck radial tires may offer several advantages over standard 90-series tubeless tires, such as:

1. Increased tread life
2. Positive handling
3. Lower vehicle height
4. Lighter weight

Care must be taken when converting to lower profile tires. Differences in overall diameter, static loaded radius and maximum load carrying capacity should be considered prior to mounting lower profile tires.

### CONVERSION TO LOW PROFILE TIRES

*Change In Overall Diameter  
(Greatec & R250F Example)*

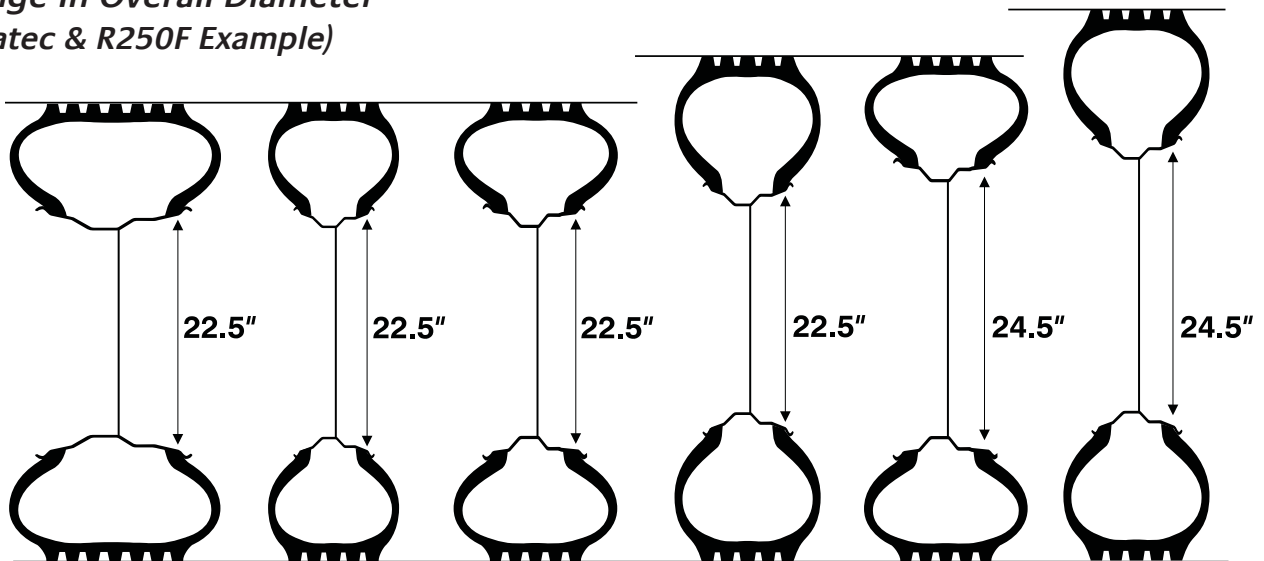

	445/50R22.5	10R22.5	295/75R22.5	11R22.5	285/75R24.5	11R24.5
<b>Overall Diameter</b>	40.2	40.0	40.2	41.3	41.9	43.3
<b>Loaded Radius</b>	19.0	18.7	18.8	19.3	19.6	20.3
<b>RPM</b>	520	519	517	503	496	480
<b>Max Load Single (lb)*</b>	10,200	5,675	6,175	6,175	6,175	6,610

\*Load Range Dependent

# Mounting/Demounting Procedures

Proper mounting procedures must be followed or sudden tire destruction, personal injury or death may result. Tire mounting must be done only by personnel trained, supervised and equipped according to Federal OSHA regulations.

## Demounting

Completely deflate tire by removing the valve core prior to removing the tire and wheel assembly from the truck.

Remove tire and wheel assembly from the vehicle and demount the tire from the wheel in the following manner:

### Tube-type

- Ensure that the tire is completely deflated before removing from the rim. Place the tire on the floor, side-ring side up.
- Pry the bead loose from the lock ring using the proper tools.
- Disassemble the rim parts carefully to avoid damage to the tire, tube, flap or rim parts.
- Turn the wheel over and unseat the second bead from the wheel.
- Remove the rim from the tire.

### Tubeless

- Ensure that the tire is completely deflated before removing from the rim.
- Break the beads loose on both sides of the tire using a bead-breaking tool.
- Lubricate both beads of the tire using a vegetable oil-based lubricant only.
- Place the tire and rim on the floor with the wide side of the rim down.
- Progressively work the tire off the rim using the proper tire irons.

### Prior to Mounting

Clean and prepare rim or wheel – inspect the rim or wheel for damage. Cracked, broken, bent, or otherwise damaged rim components and wheels must not be reworked, welded, brazed or otherwise heated. Never weld a rim with a tire mounted on it or any other time.

Proper size tube and flaps (if applicable) must be installed in the tire. New Bridgestone tubes and flaps must be used when mounting new Bridgestone tube type tires. Never use undersized, oversized, or used tubes or flaps. Ensure that rim components are properly matched and that the proper size rim is being used (size, bead taper, etc.).

New valves, cores, caps, and O-rings should be installed with new tires. Never mount a damaged tire.

## Mounting

### Tube-type

- Remove the tube and flap from the tire (if installed). Clean and dry the inside of the tire to ensure that all moisture, dirt and foreign material is removed prior to mounting.
- Install the proper size tube and flap. Always install new Bridgestone radial tubes and radial flaps in new Bridgestone radial tires. Be sure tubes marked “radial” are used in radial tires. Place the tube inside the tire and install the flap, ensuring that the flap is centered. Slightly inflate the tube enough to shape it out.
- Lubricate the beads, rim side of the flap and the tube base with a vegetable-based lubricant. Do not over-lubricate (inside of tire must stay dry).
- Mount the tire, tube and flap assembly on the rim.
- Assemble the rim parts making sure proper components are used and a proper fit is established.
- When inflating, always place the tire in an approved safety cage or equivalent restraining device and use an extension hose and clip-on chuck.
- Never stand over a tire while inflating. Do not attempt to seat rim components by tapping with a mallet when tire is inflated.

### Tubeless

- Clean and prepare rim or wheel.
- Replace valve seals and stem.
- Lubricate both beads and both rim flanges.
- Work the tire over the rim flanges using proper tubeless tire tools.
- Mount the tire over the valve side.
- Inflate tire in safety cage to seat beads.
- Do not exceed the maximum inflation pressures shown on tire sidewall/rim.

**WARNING:** When mounting truck tires, never use pressures above 40 psi to seat tire beads. If beads have not seated by the time pressure reaches 40 psi, deflate the assembly, reposition the tire on the rim, re-lubricate tire beads, rim humps, bead seat, and re-inflate.

### Cautions

- Always inflate tire/rim assembly in an approved safety cage or equivalent restraining device, use remote controlled clip-on air hose, and inflate to pressure recommended by vehicle manufacturer.

- Always ensure that rim components fit properly before inflating.
- Never tap component parts with a mallet while the tire is inflated.
- Never attempt to disassemble multi-piece rims while inflated.
- Do not exceed the maximum inflation pressure on the sidewall of the tire. If beads do not seat at 40 psi, deflate, re-lubricate and re-inflate.

**WARNING:** Never pour or spray any flammable substance into or onto a tire or wheel for any purpose whatsoever. The residue left by the substance could result in a fire or explosion, which could cause an accident.

**WARNING:** Never pour or spray a flammable substance such as gasoline or ethyl ether into a tire and light with a match so that the resulting explosion seats the beads of a tubeless tire. This practice is extremely dangerous and can result in a severe explosion or undetected damage to the tire or rim which can cause severe injury or death.

**WARNING:** Always replace a tire on a rim with another tire of exactly the same bead diameter as the diameter of the rim on which it will be mounted.

## Correct Rim Selection

Bridgestone tires are designed to be used on wheels and rims that conform to the dimensions and contours shown in the Tire and Rim Association Yearbook for the year in which the tire is manufactured and that are designed as approved wheels and rims for each particular tire size and type.

Usage of other wheels and rims must be expressly approved by Bridgestone Firestone North American Tire, LLC for the particular application involved.

The load and cold inflation pressure must not exceed the rim and wheel manufacturer's recommendations even though the tire may be approved for a higher load or inflation.

Rims and wheels may be identified (stamped) with a maximum load and maximum cold inflation rating. For rims and wheels not so identified or for service conditions exceeding the rated capacities, consult the rim and wheel manufacturer to determine rim and wheel capacities for the intended service.

### Tire & Rim Matching Importance

Remember the importance of proper matching of tires and rims. In particular, special care must also be used in the mounting of any 16" diameter tire sizes, as well as the 15.5" and 17.5" sizes. The 16" size tire must be mounted only on the approved 16" rims and not the 15.5" or 16.5" rims. In addition, any 15" size tire must be mounted only on approved 15" rims, not a 15.5" rim and any 17" size tire must be mounted only on approved 17" rims, not on a 17.5" rim.

**WARNING:** There is a danger in installing a tire of one rim diameter on a rim of a different rim diameter. If attempts are made to mount and inflate a 15" diameter tire on a 15.5" rim, a 16" tire on a 16.5" rim, or a 17" tire on a 17.5" rim, serious injury or death may result.

Rims of different diameters and tapers cannot be interchanged. The following diagram illustrates the difference between rims of two different tapers and diameters:

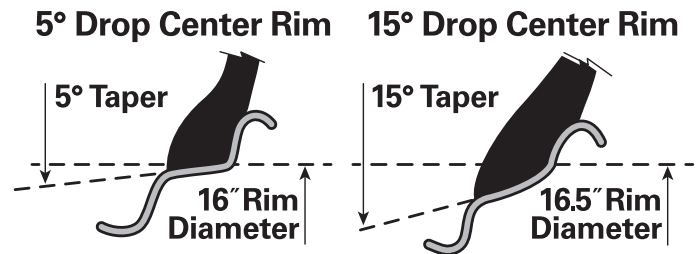

The following diagram shows how the beads of a 16" tire will not seat on a 16.5" rim. The beads should not be forced out against the rim flanges by using more air pressure, because this will break the beads and the tire will explode. Never exceed 40 psi when seating the beads on the rims.



## Use of Lubricants In Mounting & Demounting of Truck/Bus Tires

Bridgestone does not recommend the use of petroleum products as a lubricant in tire mounting or demounting operations.

Only a vegetable oil-based lubricant should be used. Do not use solvents or petroleum products as lubricants for tire mounting or demounting.

In cases where a tire submitted for adjustment consideration for bead-related damages shows evidence of having been contaminated by petroleum lubricants or other non-recommended material, the adjustment will be disallowed by Bridgestone. The use of non-recommended (products or materials may result in deterioration of rubber and eventual failure of the tire.)

Acceptable lubricants such as Murphy's, Ru-Glyde, Sliptac, etc. are recommended for (mounting and demounting passenger and truck/bus tires.)

## Tire Vibration

**SAFETY WARNING:** Serious injury or death may result from a tire failure. Many tire failures are preceded by vibration, bumps, bulges or other anomalies. If an unusual vibration occurs while driving your vehicle or you notice a bump, bulge, or an anomaly not associated with normal tire performance, have your tires and vehicle evaluated by a qualified service person.

## Repair & Retreading

Improperly repaired or retreaded truck tires may cause sudden tire destruction.

Bridgestone truck tires should only be retreaded and repaired by trained personnel.

An inspection of each tire should be done before operating the vehicle. Damaged tires should be inspected by an authorized Bridgestone tire dealer.

A puncture left unrepaired may result in further internal casing damage and eventual tire destruction.

Never use plug-only repairs on Bridgestone truck tires. An interior patch with plug or other approved material is required. Nail hole repairs should be made only after demounting and inspecting the interior of the tire.

Never use a tube as a substitute for a proper tire repair.

### ***Belt Removal***

1. The removal of the fourth (outer) belt is permissible. This belt may be omitted when retreading.
2. The removal of the third belt is more involved. If it is essential that the third belt be removed, then it must be replaced before retreading.
3. A nail hole repair of  $\frac{3}{8}$ " or less in diameter may be made in the crown area of either radial or bias tires. A section repair in a radial is required to repair any injury larger than a  $\frac{3}{8}$ " nail hole.
4. Bias section repairs are made when the injury is either larger than  $1\frac{1}{4}$ " in diameter, is not perfectly round or perpendicular to the liner surface, or when the injury is larger than  $\frac{3}{8}$ " in diameter and combination patch plugs are not used.

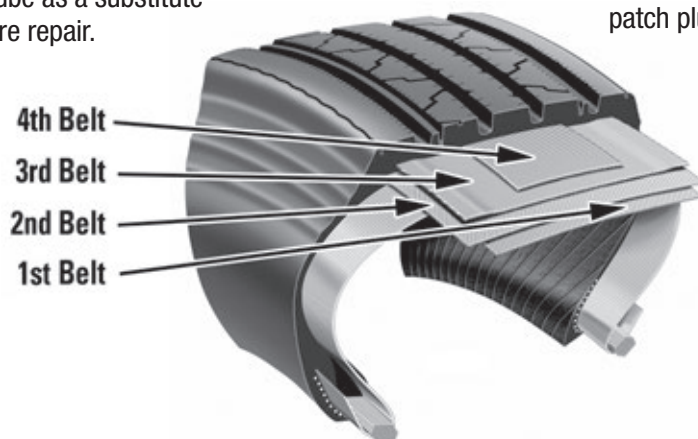

# Large Truck Fuel Economy

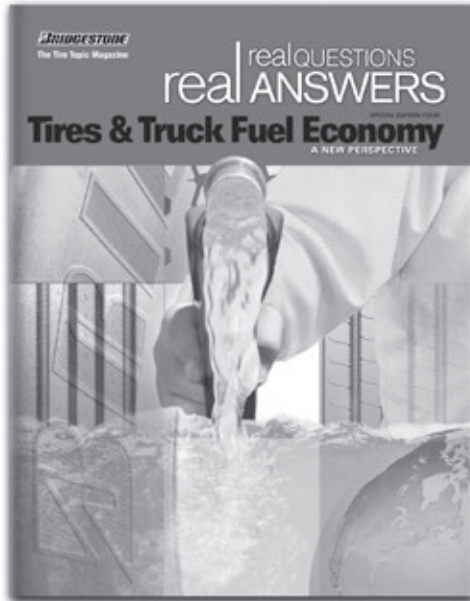

## A NEW PERSPECTIVE

**Anything you do to save fuel will improve your profitability – if it doesn't cost more than it saves.**

Bridgestone Commercial Solutions (BCS) has been studying the relationship of tires to fuel economy for over a quarter of a century. What follows summarizes that research.

For a detailed look at truck tire fuel economy, ask your BCS representative for a copy of **Tires & Truck Fuel Economy**, a *Real Answers* magazine "Special Edition." You may also view this publication online or order copies by visiting [BridgestoneTrucktires.com](http://BridgestoneTrucktires.com).

Today's trucks have an estimated engine efficiency of approximately 40 percent. Therefore, only about 40 percent of the energy converted from diesel fuel reaches the axles. Some things influence use of this 40 percent of available energy more than others. We'll take them in order, starting with some of the largest.

## What affects "real world" fuel economy?

Just as trucking is "a business of pennies," so is truck fuel economy. Tires are just one of many components affecting fuel economy, but one of the easiest to change and test.

Remember though, because of the difficulty of controlling variables in the real world, test results can vary considerably from what you find in day-to-day operations.

### Factors Affecting Fuel Economy in the Real World

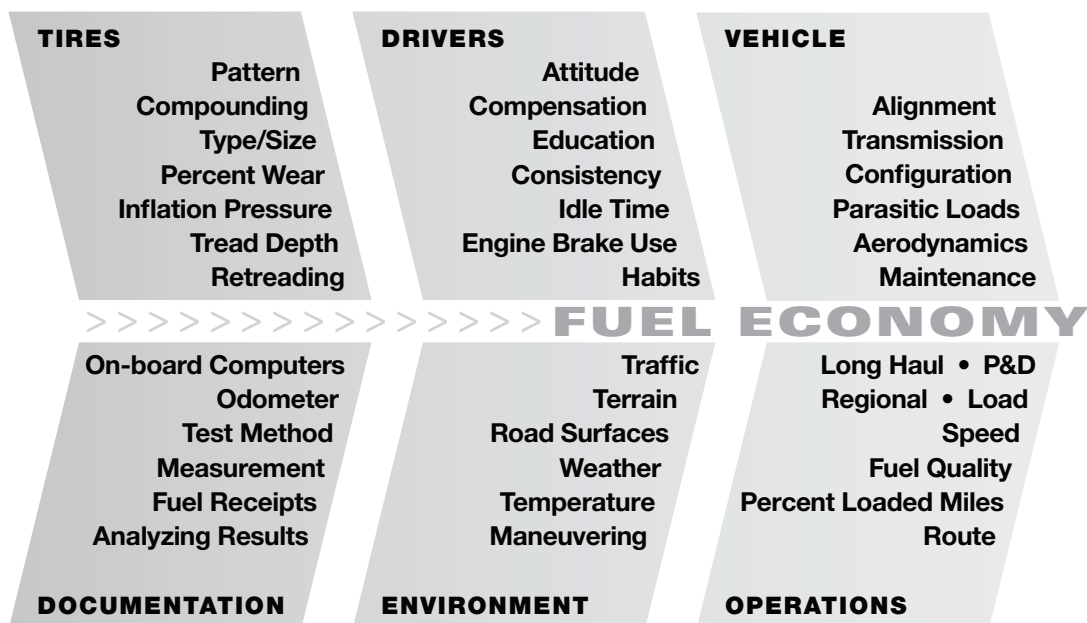

## How much benefit can we get?

A fleet with average fuel economy of 5.0 miles per gallon that achieves a given percentage of fuel savings will save more fuel than a fleet with an average fuel economy of 7.0 miles per gallon.

Fleet size and annual miles also have an effect. The more fuel you use, the more you have to gain from any improvement.

SAMPLE FUEL ECONOMY CALCULATIONS							
MILES PER YEAR	100,000	100,000	100,000	100,000	100,000	100,000	100,000
MILES PER GALLON	<b>5.0</b>	5.5	6.0	6.5	<b>7.0</b>	7.5	8.0
GALLONS PER YEAR	20,000	18,182	16,667	15,385	14,286	13,333	12,500
<b>1% Fuel Savings</b>	<b>200</b>	182	167	154	<b>143</b>	133	125
<b>2% Fuel Savings</b>	400	364	333	308	286	267	250
<b>5% Fuel Savings</b>	1,000	909	833	769	714	667	625
<b>7% Fuel Savings</b>	1,400	1,273	1,167	1,077	1,000	933	875
<b>10% Fuel Savings</b>	2,000	1,818	1,667	1,538	1,429	1,333	1,250

## How do we know how much we're saving?

First, you have to know what your fuel economy is right now. Because it changes constantly, with weather, loads, roads, equipment and drivers, that may not be as simple as it sounds.

Scientific testing controls variables, but you may not have that kind of control in the real world.

And, in-truck on-board computers may not be your best guide. According to TMC, these displays can be in error plus or minus five percent.

**According to TMC, on-board computer displays of fuel economy can be off by ±5%**

One method that's real world is to take your fuel receipts and corresponding odometer readings, then divide miles by gallons. The more data you have, the more representative your "average" is going to be.

And remember, consider the cost of any fuel economy tactic. If it costs more than it saves, it's a bad investment.

## Advanced computer methods

Your BCS representative has an innovative computer program that accurately compares the fuel economy of different tires, tires from different manufacturers, even retreads.

This program, *Tire Life Cycle Cost (TLCC)*, makes a true comparison by compensating for the fact that tire fuel economy changes constantly throughout tread life, and by accounting for differences in tire prices, casing values, installation costs and tread life.

*TLCC* will show you not only what the costs are, but what portion are for tread wear and what portion are for fuel consumed by the tires.

It's the most accurate "What if?"-way to select tires that will perform best. And only BCS has TLCC. Ask your representative to show you how much you can save.

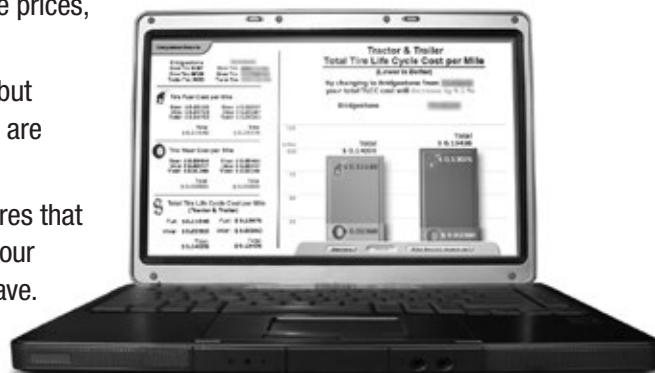

# What consumes fuel?

## SPEED

Every bit of energy produced or used by a truck comes from the fuel in the tank.

To move a truck, you must first run the engine to get power to the tires. With 40 percent engine efficiency, 60 percent of fuel is consumed through engine losses, the remaining 40 percent of fuel is consumed by tire rolling resistance, air resistance and all other mechanical losses. At 55 mph or below tire rolling resistance, air resistance and mechanical losses each account for about 33 percent of the 40 percent of fuel from the engine efficiency.

For example, increasing speed from 55 mph to 75 mph can take 39 percent more fuel, and much of that results from air resistance.

### Speed affects other things too

In tests, vehicles went from 5.1 miles per gallon at 75 mph to 7.1 miles per gallon at 55 mph.

Speed also affects travel time, and therefore, the number of miles a driver can log each day. If you can meet delivery schedules without running out of hours of service, cutting speed can be an effective way to save fuel.

### Fuel Economy at Different Speeds

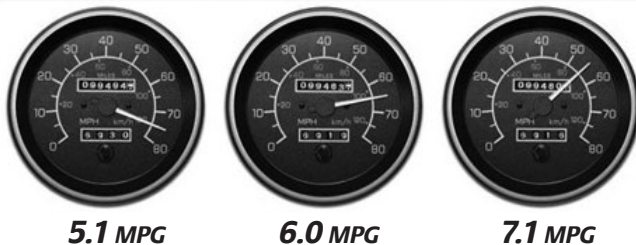

### Fuel Economy & Travel Time at Different Speeds

Running at higher speeds can also have effects: Tire fuel efficiency, even with fuel-efficient tires, is severely cut.

And, engine manufacturers estimate maintenance costs may be 10-15 percent higher, while tire wear can be shortened by 10 to 30 percent.

SPEED	MILES PER GALLON	INCREASE IN MILES PER GALLON	PERCENT FUEL SAVED	TIME FOR 500 MILES OF TRAVEL	INCREASE IN TRAVEL TIME
75	5.1	—	—	6 hr. 40 min.	—
65	6.0	18%	15%	7 hr. 42 min.	15.5%
55	7.1	39%	28.2%	9 hr. 5 min.	36.2%

## Effect of Speed on Fuel Efficiency Factors

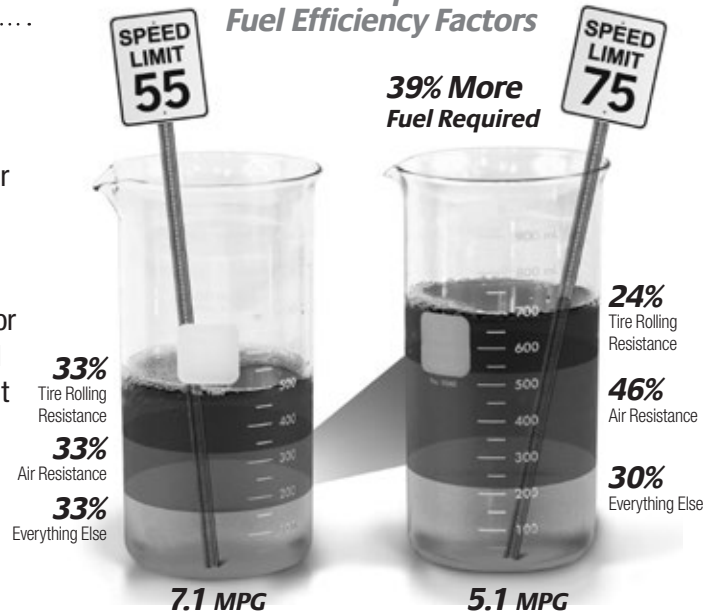

## LOAD

No one would reduce payload as a way to save fuel, but there are ways to increase payload – by decreasing non-paying load.

Wide base tires weigh significantly less than dual pairs. With some cargoes, this can allow increased payload, and more revenue.

If the tires they replace were not fuel-efficient, wide base tires may also contribute to fuel economy.



Wide base tires can allow weight savings to be converted into revenue-producing payload and may be more fuel-efficient than ordinary dual assemblies.

### Tire Contributions to the Fuel Bill

Of the fuel used in moving the vehicle, about 1/4 to 1/3 of it is used to overcome rolling resistance. So if rolling resistance decreases by 10 percent the result is about (1/4 x 10% =) 2.5% to (1/3 x 10% =) 3% decrease in fuel consumption.



### What consumes fuel?

continued

## ROLLING RESISTANCE

The tread contributes about 35-50 percent of the tire's overall rolling resistance, while the casing contributes about 50 to 65 percent.

35-50%  
TREAD  
COMPOUND

50-65%  
CASING

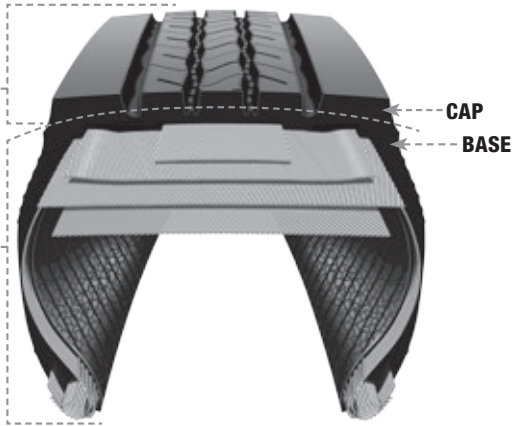

### Wear effect on rolling resistance

Since the contribution of the tread is large, as the tread wears away, rolling resistance decreases.

As they approach wear-out, many tires become very similar in rolling resistance, even if they started out quite different.

That's one reason the BCS TLCC program uses true average rolling resistance – not new-tire rolling resistance – to calculate tire fuel consumption.



### Tread design

Tread design also affects rolling resistance. In general, rib-type designs are more fuel-efficient than block- or lug-types. And, a tire with a shallower tread tends to be more fuel-efficient.

With drive tires, designs incorporating continuous shoulder ribs are so resistant to irregular wear that designers can use very fuel-efficient tread compounds.

Computer analysis, like that of the BCS TLCC program, can help you decide which tires deliver the best fuel efficiency.

### Fuel economy with retreads

If only the tread is modified to produce fuel economy, the fuel efficiency of the tire may end when it is retreaded, unless it's retreaded with a fuel-efficient tread.

Fortunately, there are a number of fuel-efficient retread materials available offering fuel economy comparable to that of the best new tires, but at a fraction of their cost.

In addition, many BCS casings are specially constructed for fuel efficiency, and when retreaded – especially when capped with a fuel-efficient tread – may help to improve fuel economy.

### Inflation pressure effects

Inflation pressure effects are relatively small, but you can expect about a 2 percent improvement in fuel efficiency over a range of 20 PSI below to 20 PSI above recommended pressure.

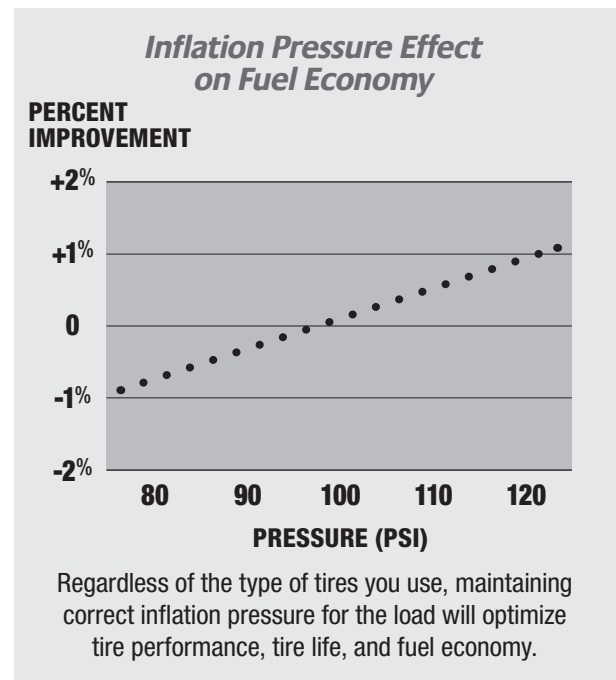

### Position contribution to fuel economy

In general, the contribution of the tires on any given axle to overall vehicle fuel efficiency is roughly determined by the amount of load on that axle.

In general, trailer tires make the largest contribution.

If you are evaluating tires, you should probably try fuel-efficient trailer tires first. If that doesn't work, changing drive and steer tires probably won't either.

### Axle Weight Distribution & Position Contribution to Fuel Economy

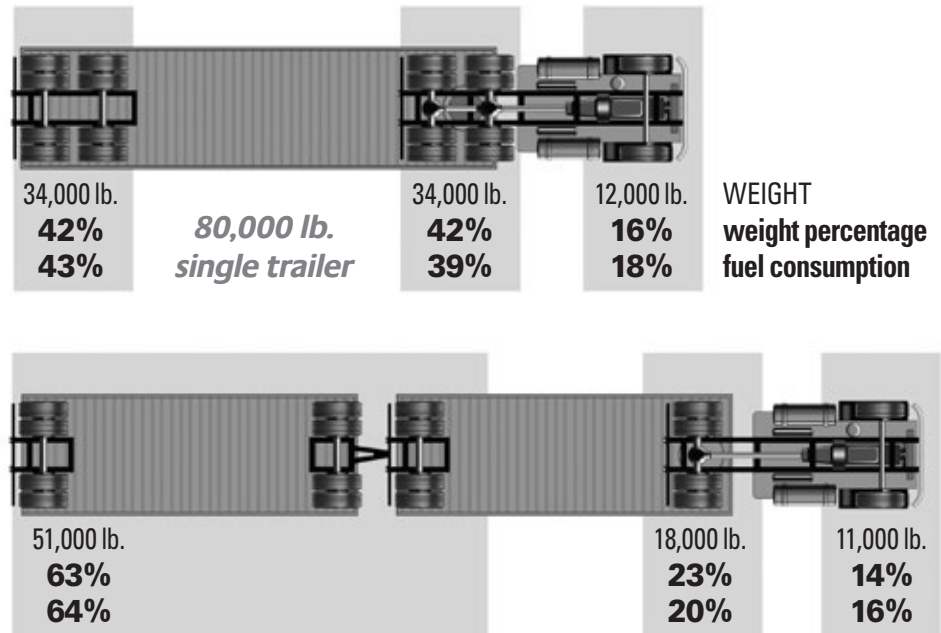

### What effect can fuel-efficient tires have?

Generally you will only see about half of the scientific test results in the real world. Much of this is because of interference by other factors outside the controlled variables of testing.

So, any fuel economy method that does not produce at least a 2-percent improvement in controlled testing will probably not produce a measurable real-world effect.

### Taking action

BCS recommends you conduct your own tests to determine whether your investment will achieve a satisfactory return.

Comparing fuel receipts with odometer readings is something you can do yourself, on an ongoing basis, to see if your fuel economy program is working.

### Try TLCC

Remember, only BCS has the **Tire Life Cycle Cost (TLCC)** program, to help you make informed tire choices.







































Your BCS representative will help you analyze your current tires (even if they are from BCS competitors), and recommend tires that will produce the lowest overall tire and fuel cost over their useful life.

Here are some steps to take:

### Recommendations

- 1 Test things yourself:** If you can't convince yourself and your accountant, what you're saving may be too small to stand out from the "noise."
- 2 Limit your investment:** Try trailer tires first, or better still, try fuel-efficient trailer retreads first.
- 3 Consider all the variables:** Fuel-efficient duals may save just as much fuel as wide base tires, without forcing you to buy new wheels. If you can't benefit from the weight savings, why spend the money?
- 4 Try other methods:** Driver behavior has a big effect on fuel economy. Driver training or incentives may be a better investment than new equipment.
- 5 Examine your priorities:** Make sure everyone is on board. If one department is trying to save fuel and another is trying to cut tire costs, they may be working against each other.
- 6 Call for help:** Your tire supplier can help you with advice and in conducting tests. Call BCS for assistance at 1-800-847-3272.

# Truck Type by Weight Class

<p>CLASS 1 6,000 lb &amp; less</p>	 Utility Van  Pick-up	 Compact Van  Multi-purpose	 Van
<p>CLASS 2 6,001-10,000 lb</p>	 Utility Van  Pick-up	 Compact Van  Walk-in	 Doubles  Liquid Tanker
<p>CLASS 3 10,001-14,000 lb</p>	 Milk Bread  Compact Van	 Walk-in	 Dry Bulk
<p>CLASS 4 14,001-16,000 lb</p>	 Conventional Van  Large Walk-in		 Logger
<p>CLASS 5 16,001-19,500 lb</p>	 Rack  Large Walk-in	 Tree Specialist	 Platform  Drop Frame
<p>CLASS 6 19,501-26,000 lb</p>	 Furniture  Coe Van	 School  Single Axle Van	 Dump
<p>CLASS 7 26,001-33,000 lb</p>	 Home Fuel  Trash	 Transit  Medium Conventional	 Reefer  Deep Drop
<p>CLASS 8 33,001 lb &amp; over</p>	 Dump  Cement	 Extra Heavy Tandem Conventional  Coe Sleeper	 Auto Trans

Note: Trailer weight not listed.

## Load & Inflation Tables

<b>Medium Commercial Truck Radials</b> .....	92 - 96
<i>Radial Ply Metric Tires on 15° Drop Center Rims</i> .....	92 - 94
<i>Radial Ply Metric Wide Base Tires as Singles</i> .....	93
<i>Radial Ply Tires on 15° Drop Center Rims</i> .....	95
<i>Radial Ply Tires on Flat Base Rims</i> .....	96
<b>Commercial Light Truck Radials</b> .....	97 - 100
<i>Radial Ply Metric Tires on 5° Drop Center Rims</i> .....	97 - 98

# Medium Commercial Truck Radials

Radial Ply METRIC Tires for Trucks, Buses & Trailers Used in Normal Highway Service

## TIRES MOUNTED ON 15° DROP CENTER RIMS

TIRE SIZE DESIGNATION	USAGE	Tire Load Limits (kg./lb.) at various Cold Inflation Pressures (Pressure Listed is the Minimum for the Load)												
		kPa	480	520	550	590	620	660	690	720	760	790	830	860
		psi	70	75	80	85	90	95	100	105	110	115	120	125
215/75R17.5 <b>M729 Only</b>	DUAL	kg.		1250	1325	1400	1470	1550	<b>1600(F)<sup>124</sup></b>					
		lb.		2760	2920	3080	3245	3420	<b>3525(F)</b>					
	SINGLE	kg.		1290	1370	1450	1520	1600	<b>1700(F)<sup>126</sup></b>					
		lb.		2850	3015	3200	3350	3530	<b>3750(F)</b>					
215/75R17.5 <b>R238 "G" Only Load Range</b>	DUAL	kg.		1270	1340	1405	1470	1535	<b>1600(G)</b>					
		lb.		2800	2950	3095	3240	3385	<b>3525(G)</b>					
	SINGLE	kg.		1350	1420	1495	1565	1635	<b>1700(G)</b>					
		lb.		2980	3135	3295	3445	3660	<b>3750(G)</b>					
215/75R17.5 <b>R238 "H" Only Load Range</b>	DUAL	kg.			1450	1520	1590	1650	1720	1790	1860	1910	1990	<b>2060(H)</b>
		lb.			3195	3350	3500	3645	3795	3945	4095	4220	4390	<b>4540(H)</b>
	SINGLE	kg.			1530	1610	1680	1750	1820	1900	1960	2040	2110	<b>2180(H)</b>
		lb.			3375	3540	3695	3860	4010	4180	4330	4495	4650	<b>4805(H)</b>
245/70R17.5	DUAL	kg.			1750	1840	1940	2030	2130	2220	2320	2420	2510	<b>2575(J)</b>
		lb.			3855	4060	4275	4485	4700	4905	5113	5330	5535	<b>5675(J)</b>
	SINGLE	kg.			1860	1960	2060	2150	2260	2360	2470	2570	2660	<b>2725(J)</b>
		lb.			4110	4330	4545	4750	4975	5210	5445	5660	5865	<b>6005(J)</b>
225/70R19.5	DUAL	kg.	1230	1300	1360	1410	1470	<b>1550(F)<sup>123</sup></b>	1580	1640	<b>1700(G)<sup>126</sup></b>			
		lb.	2720	2860	3000	3115	3245	<b>3415(F)<sup>123</sup></b>	3490	3615	<b>3750(G)<sup>126</sup></b>			
	SINGLE	kg.			1450	1500	1570	<b>1650(F)<sup>125</sup></b>	1690	1740	<b>1800(G)<sup>128</sup></b>			
		lb.			3195	3315	3450	<b>3640(F)<sup>125</sup></b>	3715	3845	<b>3970(G)<sup>128</sup></b>			
245/70R19.5	DUAL	kg.			1550	1590	1660	<b>1750(F)<sup>127</sup></b>	1790	1850	<b>1950(G)<sup>131</sup></b>	2060	<b>2120(H)</b>	
					3415	3515	3655	<b>3860(F)<sup>127</sup></b>	3940	4075	<b>4300(G)<sup>131</sup></b>	4540	<b>4675(H)</b>	
SINGLE	kg.			1650	1700	1770	<b>1850(F)<sup>129</sup></b>	1900	1970	<b>2060(G)<sup>133</sup></b>	2180	<b>2240(H)</b>		
				3640	3740	3890	<b>4080(F)<sup>129</sup></b>	4190	4335	<b>4540(G)<sup>133</sup></b>	4805	<b>4940(H)</b>		
265/70R19.5	DUAL	kg.			1700	1780	1860	1950	2000	2170	<b>2360(G)<sup>138</sup></b>			
		lb.			3745	3925	4100	4300	4410	4785	<b>5205(G)<sup>138</sup></b>			
	SINGLE	kg.			1800	1900	1970	2060	2200	2340	<b>2500(G)<sup>140</sup></b>			
		lb.			3970	4190	4345	4540	4850	5205	<b>5510(G)<sup>140</sup></b>			
285/70R19.5	DUAL	kg.				1980	2000	2120	2150	2220	<b>2300(G)<sup>137</sup></b>	2380	2570	<b>2725(H)<sup>143</sup></b>
		lb.				4365	4400	4675	4735	4900	<b>5070(G)<sup>137</sup></b>	5255	5675	<b>6005(H)<sup>143</sup></b>
	SINGLE	kg.				2110	2190	2300	2360	2440	<b>2500(G)<sup>140</sup></b>	2600	2800	<b>2900(H)<sup>145</sup></b>
		lb.				4645	4835	5070	5205	5385	<b>5510(G)<sup>140</sup></b>	5740	6175	<b>6395(H)<sup>145</sup></b>
305/70R19.5 <b>R227F Only</b>	DUAL	kg.			2060	2120	2200	2300	2370	2450	<b>2575(H)<sup>141</sup></b>	2620	2725	<b>2900(J)<sup>145</sup></b>
		lb.			4540	4670	4860	5070	5230	5410	<b>5675(H)<sup>141</sup></b>	5770	6005	<b>6395(J)<sup>145</sup></b>
	SINGLE	kg.			2240	2330	2420	2500	2610	2700	<b>2800(H)<sup>144</sup></b>	2870	3000	<b>3150(J)<sup>148</sup></b>
		lb.			4940	5130	5340	5510	5745	5945	<b>6175(H)<sup>144</sup></b>	6340	6610	<b>6945(J)<sup>148</sup></b>

NOTES: Letters in parentheses denote Load Range for which boldface loads and inflations are maximum.

International Load Index numbers are shown after Load Range.

IMPORTANT — Always use approved tire and rim combinations for diameter and contours.

# Medium Commercial Truck Radials

METRIC WIDE BASE Radial Tires for Trucks, Buses & Trailers Used in Normal Highway Service

TIRES ARE USED AS SINGLES														
TIRE SIZE DESIGNATION	Tire Load Limits (kg./lb.) at various Cold Inflation Pressures (Pressure Listed is the Minimum for the Load)													
	kPa	480	520	550	590	620	660	690	720	760	790	830	860	900
	psi	70	75	80	85	90	95	100	105	110	115	120	125	130
445/65R19.5	kg.	3410	3610	3750	3960	4100	4250	4410	4540	<b>4750(J)</b> <sup>162</sup>				
	lb.	7540	7930	8270	8680	9040	9370	9730	10100	<b>10500(J)</b>				
445/50R22.5	kg.	2980	3150	3330	3480	3640	3810	3970	4120	<b>4250(J)</b> <sup>158</sup>	4430	<b>4625(L)</b> <sup>161</sup>		
	lb.	6570	6940	7310	7680	8030	8390	8740	9090	<b>9370(J)</b> <sup>158</sup>	9780	<b>10200(L)</b> <sup>161</sup>		
455/55R22.5	kg.	3220	3400	3580	3760	3940	4110	4280	4450	<b>4625(J)</b> <sup>161</sup>	4790	<b>5000(L)</b> <sup>164</sup>		<b>5300(M)</b>
	lb.	7100	7500	7900	8290	8680	9060	9440	9820	<b>10200(J)</b> <sup>161</sup>	10600	<b>11000(L)</b> <sup>164</sup>		<b>11700(M)</b>
385/65R22.5 Except R244	kg.	2880	3060	3150	3350	3470	3650	3740	3850	4000	4100	<b>4250(J)</b> <sup>158</sup>		
	lb.	6380	6720	6940	7350	7650	8050	8230	8510	8820	9050	<b>9370(J)</b> <sup>158</sup>		
385/65R22.5 R244 Only	kg.		3060	3150	3350	3470	3650	3740	3850	4000	4100	4250	4340	<b>4500(L)</b> <sup>160</sup>
	lb.		6720	6940	7350	7650	8050	8230	8510	8820	9050	9370	9610	<b>9920(L)</b>
425/65R22.5 Except R244	kg.	3430	3640	3750	3980	4130	4250	4440	4580	<b>4750(J)</b> <sup>162</sup>	4880	<b>5150(L)</b> <sup>165</sup>		
	lb.	7590	7990	8270	8740	9100	9370	9790	10100	<b>10500(J)</b>	10700	<b>11400(L)</b> <sup>165</sup>		
425/65R22.5 R244 Only	kg.		3640	3750	3980	4130	4250	4440	4580	4750	4880	<b>5150(L)</b> <sup>165</sup>		
	lb.		7990	8270	8740	9100	9370	9790	10100	10500	10700	<b>11400(L)</b> <sup>165</sup>		
445/65R22.5 Except R244 & M854	kg.	3720	3950	4125	4320	4470	<b>4620(H)</b> <sup>161</sup>	4820	4960	5150	5290	<b>5600(L)</b> <sup>168</sup>		
	lb.	8230	8660	9090	9480	9870	<b>10200(H)</b> <sup>161</sup>	10600	11000	11400	11700	<b>12300(L)</b> <sup>168</sup>		
445/65R22.5 R244 & M854	kg.			4125	4320	4470	4625	4820	4960	5150	5290	5600	5700	<b>5800(M)</b> <sup>169</sup>
	lb.			9090	9480	9870	10200	10600	11000	11400	11700	12300	12600	<b>12800(M)</b> <sup>169</sup>

## Radial Ply METRIC Tires for Trucks, Buses & Trailers Used in Normal Highway Service

TIRES MOUNTED ON 15° DROP CENTER RIMS														
TIRE SIZE DESIGNATION	USAGE	Tire Load Limits (kg./lb.) at various Cold Inflation Pressures. Pressure Listed is the Minimum for the Load												
		kPa	520	550	590	620	660	690	720	760	790	830	860	900
		psi	75	80	85	90	95	100	105	110	115	120	125	130
255/70R22.5	DUAL	kg.		1800	1860	1940	2000	2020	2090	<b>2120(G)</b> <sup>134</sup>	2230	<b>2300(H)</b> <sup>137</sup>		
		lb.		3970	4110	4275	4410	4455	4610	<b>4675(G)</b> <sup>134</sup>	4915	<b>5070(H)</b> <sup>137</sup>		
	SINGLE	kg.		1900	1980	2060	2120	2220	2300	<b>2360(G)</b> <sup>138</sup>	2450	<b>2500(H)</b> <sup>140</sup>		
		lb.		4190	4370	4550	4675	4895	5065	<b>5205(G)</b> <sup>138</sup>	5400	<b>5510(H)</b> <sup>140</sup>		
275/70R22.5 R250F / ED Load Range "J" Only	DUAL	kg.			2180	2300	2430	2500	2575	2725	2800	<b>2900(J)</b> <sup>145</sup>		
		lb.			4805	5070	5355	5510	5675	6005	6175	<b>6395(J)</b> <sup>145</sup>		
	SINGLE	kg.			2430	2500	2650	2725	2900	3000	3075	<b>3175(J)</b>		
		lb.			5355	5510	5840	6005	6395	6610	6940	<b>7000(J)</b>		
275/70R22.5 M840 Load Range "J" Only	DUAL	kg.			2180	2300	2430	2500	2575	2725	2800	<b>2900(J)</b> <sup>145</sup>		
		lb.			4805	5070	5355	5510	5675	6005	6175	<b>6395(J)</b> <sup>145</sup>		
	SINGLE	kg.			2360	2500	2650	2725	2800	2900	3075	<b>3150(J)</b> <sup>148</sup>		
		lb.			5205	5510	5840	6005	6175	6395	6780	<b>6940(J)</b> <sup>148</sup>		

NOTES: Letters in parentheses denote Load Range for which boldface loads and inflations are maximum.

International Load Index numbers are shown after Load Range.

IMPORTANT — Always use approved tire and rim combinations for diameter and contours.

# Medium Commercial Truck Radials

Radial Ply METRIC Tires for Trucks, Buses & Trailers Used in Normal Highway Service

TIRES MOUNTED ON 15° DROP CENTER RIMS														
TIRE SIZE DESIGNATION	USAGE	Tire Load Limits (kg./lb.) at various Cold Inflation Pressures (Pressure Listed is the Minimum for the Load)												
		kPa	480	520	550	590	620	660	690	720	760	790	830	860
		psi	70	75	80	85	90	95	100	105	110	115	120	125
245/75R22.5	DUAL	kg.	1430	1500	1600	1640	1710	1800	1840	1900	1950(G) <sup>131</sup>			
		lb.	3160	3315	3525	3615	3765	3970	4055	4195	4300(G)			
	SINGLE	kg.	1570	1650	1750	1800	1880	1950	2020	2090	2120(G) <sup>134</sup>			
		lb.	3470	3645	3860	3975	4140	4300	4455	4610	4675(G)			
265/75R22.5	DUAL	kg.	1600	1680	1750	1830	1910	2000	2050	2130	2180(G) <sup>131</sup>			
		lb.	3525	3705	3860	4040	4205	4410	4525	4685	4805(G)			
	SINGLE	kg.	1760	1850	1950	2010	2100	2180	2260	2340	2360(G) <sup>138</sup>			
		lb.	3875	4070	4300	4440	4620	4805	4975	5150	5205(G)			
295/75R22.5 "G" Only Load Range	DUAL	kg.	1860	1950	2060	2130	2220	2300	2390	2470	2575(G) <sup>141</sup>			
		lb.	4095	4300	4540	4690	4885	5070	5260	5440	5675(G)			
	SINGLE	kg.	2040	2140	2240	2340	2440	2500	2620	2710	2800(G) <sup>144</sup>			
		lb.	4500	4725	4940	5155	5370	5510	5780	5980	6175(G)			
295/75R22.5 "H" Only Load Range	DUAL	kg.	2030	2130	2240	2320	2420	2500	2600	2690	2800	2870	3000(H) <sup>143</sup>	
		lb.	4470	4690	4940	5120	5330	5510	5740	5940	6175	6330	6610(H)	
	SINGLE	kg.	2230	2340	2430	2550	2660	2725	2860	2960	3075	3150	3250(H) <sup>148</sup>	
		lb.	4915	5155	5355	5630	5860	6005	6305	6525	6780	6950	7160(H)	
295/60R22.5	DUAL	kg.			2190	2290	2395	2495	2595	2690	2790	2885	2980	3075(J) <sup>147</sup>
		lb.			4825	5050	5275	5495	5715	5930	6145	6360	6570	6780(J)
	SINGLE	kg.			2385	2495	2610	2715	2825	2930	3040	3145	3230	3350(J) <sup>150</sup>
		lb.			5260	5505	5750	5990	6230	6465	6700	6930	7160	7390(J)
315/80R22.5	DUAL	kg.		2575	2650	2750	2900	2970	3070	3150	3270	3450(J) <sup>151</sup>	3590	3750(L) <sup>154</sup>
		lb.		5675	5840	6070	6395	6545	6770	6940	7210	7610(J)	7910	8270(L)
	SINGLE	kg.		2800	2910	3030	3150	3260	3370	3450	3590	3750(J) <sup>154</sup>	3940	4125(L) <sup>157</sup>
		lb.		6175	6415	6670	6940	7190	7440	7610	7920	8270(J)	8690	9090(L)
315/80R22.5 M860A Only	DUAL	kg.		2575	2650	2750	2900	2970	3070	3150	3270	3450(J) <sup>151</sup>	3795	4125(L) <sup>157</sup>
		lb.		5675	5840	6070	6395	6545	6770	6940	7210	7610(J)	8350	9090(L)
	SINGLE	kg.		2800	2910	3030	3150	3260	3370	3450	3590	3750(J) <sup>154</sup>	4150	4355(L)
		lb.		6175	6415	6670	6940	7190	7440	7610	7920	8270(J)	9135	10000(L)
295/80R22.5	DUAL	kg.			2345	2450	2560	2665	2775	2880	2980	3085	3150(H) <sup>148</sup>	
		lb.			5165	5405	5645	5880	6115	6345	6575	6805	6940(H)	
	SINGLE	kg.			2640	2765	2890	3010	3130	3250	3365	3480	3550(H) <sup>152</sup>	
		lb.			5825	6100	6370	6635	6900	7160	7420	7675	7830(H)	
285/75R24.5	DUAL	kg.	1870	1970	2060	2150	2240	2360(F) <sup>138</sup>	2410	2490	2575(G) <sup>141</sup>	2660	2800(H) <sup>144</sup>	
		lb.	1435	4340	4540	4740	4930	5205(F)	5310	5495	5675(G)	5860	6175(H)	
	SINGLE	kg.	2060	2160	2240	2360	2460	2575(F) <sup>141</sup>	2650	2740	2800(G) <sup>144</sup>	2920	3075(H) <sup>147</sup>	
		lb.	4545	4770	4940	5210	5420	5675(F)	5835	6040	6175(G)	6440	6780(H)	

NOTES: Letters in parentheses denote Load Range for which boldface loads and inflations are maximum.

International Load Index numbers are shown after Load Range.

IMPORTANT — Always use approved tire and rim combinations for diameter and contours.

# Medium Commercial Truck Radials

Radial Ply Tires for Trucks, Buses & Trailers Used in Normal Highway Service

## TIRES MOUNTED ON 15° DROP CENTER RIMS

TIRE SIZE DESIGNATION	USAGE	Tire Load Limits (kg./lb.) at various Cold Inflation Pressures (Pressure Listed is the Minimum for the Load)											
		kPa	590	620	660	690	720	760	790	830	860	900	930
		psi	85	90	95	100	105	110	115	120	125	130	135
9R17.5HC	DUAL	kg.	1380	1430	1480	1520	<b>1600(F)</b> <sup>124</sup>	1650	1700	<b>1750(G)</b> <sup>127</sup>	1800	1850	<b>1900(H)</b> <sup>130</sup>
		lb.	3040	3150	3260	3360	<b>3525(F)</b>	3635	3745	<b>3860(G)</b>	3970	4080	<b>4190(H)</b>
	SINGLE	kg.	1450	1520	1570	1630	<b>1700(F)</b> <sup>126</sup>	1750	1800	<b>1850(G)</b> <sup>129</sup>	1900	1950	<b>2000(H)</b> <sup>132</sup>
		lb.	3200	3340	3470	3590	<b>3750(F)</b>	3860	3970	<b>4080(G)</b>	4190	4300	<b>4410(H)</b>

		kPa	480	520	550	590	620	660	690	720	760	790	830
		psi	70	75	80	85	90	95	100	105	110	115	120
				kg.									
8R19.5	DUAL	kg.	1120	1170	<b>1215(D)</b> <sup>115</sup>	1285	1310	<b>1360(E)</b> <sup>119</sup>	1410	1460	<b>1500(F)</b> <sup>122</sup>		
		lb.	2460	2570	<b>2680(D)</b>	2785	2890	<b>3000(E)</b>	3100	3200	<b>3305(F)</b>		
	SINGLE	kg.	1150	1220	<b>1285(D)</b> <sup>117</sup>	1340	1400	<b>1450(E)</b> <sup>121</sup>	1500	1550	<b>1600(F)</b> <sup>124</sup>		
		lb.	2540	2680	<b>2835(D)</b>	2955	3075	<b>3195(E)</b>	3305	3415	<b>3525(F)</b>		
9R22.5	DUAL	kg.	1480	1550	1610	1670	<b>1750(E)</b> <sup>127</sup>	1820	1890	<b>1950(F)</b> <sup>131</sup>	2010	2070	<b>2210(G)</b> <sup>134</sup>
		lb.	3270	3410	3550	3690	<b>3860(E)</b>	4005	4150	<b>4300(F)</b>	4425	4550	<b>4675(G)</b>
	SINGLE	kg.	1530	1610	1690	1760	<b>1850(E)</b> <sup>129</sup>	1920	1990	<b>2060(F)</b> <sup>133</sup>	2120	2180	<b>2240(G)</b> <sup>136</sup>
		lb.	3370	3560	3730	3890	<b>4080(E)</b>	4235	4390	<b>4540(F)</b>	4675	4810	<b>4940(G)</b>
10R22.5	DUAL	kg.	1750	1830	1910	<b>2000(E)</b> <sup>132</sup>	2080	2160	<b>2240(F)</b> <sup>136</sup>	2300	2360	<b>2430(G)</b> <sup>139</sup>	
		lb.	3860	4045	4230	<b>4410(E)</b>	4585	4760	<b>4940(F)</b>	5075	5210	<b>5355(G)</b>	
	SINGLE	kg.	1850	1940	2030	<b>2120(E)</b> <sup>134</sup>	2200	2280	<b>2360(F)</b> <sup>138</sup>	2430	2500	<b>2575(G)</b> <sup>141</sup>	
		lb.	4080	4280	4480	<b>4675(E)</b>	4850	5025	<b>5205(F)</b>	5360	5515	<b>5675(G)</b>	
11R22.5	DUAL	kg.	1990	2080	2160	2250	<b>2360(F)</b> <sup>138</sup>	2460	2560	<b>2650(G)</b> <sup>142</sup>	2680	2710	<b>2725(H)</b> <sup>143</sup>
		lb.	4380	4580	4760	4950	<b>5205(F)</b>	5415	5625	<b>5840(G)</b>	5895	5950	<b>6005(H)</b>
	SINGLE	kg.	2050	2160	2260	2370	<b>2500(F)</b> <sup>140</sup>	2600	2700	<b>2800(G)</b> <sup>144</sup>	2870	2940	<b>3000(H)</b> <sup>146</sup>
		lb.	4560	4770	4990	5220	<b>5510(F)</b>	5730	5950	<b>6175(G)</b>	6320	6465	<b>6610(H)</b>
11R24.5	DUAL	kg.	2110	2210	2300	2390	<b>2500(F)</b> <sup>140</sup>	2580	2660	<b>2725(G)</b> <sup>143</sup>	2820	2910	<b>3000(H)</b> <sup>146</sup>
		lb.	4660	4870	5070	5260	<b>5510(F)</b>	5675	5840	<b>6005(G)</b>	6205	6405	<b>6610(H)</b>
	SINGLE	kg.	2190	2300	2410	2520	<b>2650(F)</b> <sup>142</sup>	2770	2890	<b>3000(G)</b> <sup>146</sup>	3080	3160	<b>3250(H)</b> <sup>149</sup>
		lb.	4820	5070	5310	5550	<b>5840(F)</b>	6095	6350	<b>6610(G)</b>	6790	6970	<b>7160(H)</b>
12R22.5	DUAL	kg.	2170	2260	2350	2440	<b>2575(F)</b> <sup>141</sup>	2630	2680	<b>2725(G)</b> <sup>143</sup>	2840	2960	<b>3075(H)</b> <sup>147</sup>
		lb.	4780	4990	5190	5390	<b>5675(F)</b>	5785	5895	<b>6005(G)</b>	6265	6525	<b>6780(H)</b>
	SINGLE	kg.	2240	2360	2470	2580	<b>2725(F)</b> <sup>141</sup>	2820	2910	<b>3000(G)</b> <sup>146</sup>	3120	3240	<b>3350(H)</b> <sup>150</sup>
		lb.	4940	5200	5450	5690	<b>6005(F)</b>	6205	6405	<b>6610(G)</b>	6870	7130	<b>7390(H)</b>
12R24.5	DUAL	kg.	2300	2400	2500	2600	<b>2650(F)</b> <sup>142</sup>	2770	2890	<b>3000(G)</b> <sup>146</sup>	3080	3160	<b>3250(H)</b> <sup>149</sup>
		lb.	5080	5300	5520	5730	<b>5840(F)</b>	6095	6350	<b>6610(G)</b>	6790	6970	<b>7160(H)</b>
	SINGLE	kg.	2380	2500	2630	2740	<b>2900(F)</b> <sup>145</sup>	3020	3140	<b>3250(G)</b> <sup>152</sup>	3350	3450	<b>3550(H)</b> <sup>152</sup>
		lb.	5240	5520	5790	6040	<b>6395(F)</b>	6650	6910	<b>7160(G)</b>	7380	7600	<b>7830(H)</b>

NOTES: Letters in parentheses denote Load Range for which boldface loads and inflations are maximum.

International Load Index numbers are shown after Load Range.

IMPORTANT — Always use approved tire and rim combinations for diameter and contours.



# Medium Commercial Truck Radials

Radial Ply Tires for Trucks, Buses & Trailers Used in Normal Highway Service

TIRES MOUNTED ON FLAT BASE RIMS													
TIRE SIZE DESIGNATION	USAGE	Tire Load Limits (kg./lb.) at various Cold Inflation Pressures (Pressure Listed is the Minimum for the Load)											
		kPa	480	520	550	590	620	660	690	720	760	790	830
		psi	70	75	80	85	90	95	100	105	110	115	120
11.00R24	DUAL	kg.	2440	2550	2660	2760	<b>2800(F)</b> <sub>144</sub>	2920	3040	<b>3150(G)</b> <sub>148</sub>	3250	3350	<b>3450(H)</b> <sub>151</sub>
		lb.	5390	5630	5860	6090	<b>6175(F)</b>	6430	6690	<b>6940(G)</b>	7160	7380	<b>7610(H)</b>
	SINGLE	kg.	2440	2550	2660	2760	<b>3075(F)</b> <sub>147</sub>	3200	3330	<b>3450(G)</b> <sub>151</sub>	3550	3650	<b>3750(H)</b> <sub>154</sub>
		lb.	5390	5630	5860	6090	<b>6780(F)</b>	7060	7340	<b>7610(G)</b>	7830	8050	<b>8270(H)</b>
12.00R24	DUAL	kg.	2780	2860	3020	3140	3250	<b>3350(G)</b> <sub>150</sub>	3450	3550	<b>3650(H)</b> <sub>153</sub>	3760	<b>3875(J)</b> <sub>155</sub>
		lb.	6120	6390	6650	6910	7160	<b>7390(G)</b>	7610	7830	<b>8050(H)</b>	8300	<b>8540(J)</b>
	SINGLE	kg.	2870	3020	3170	3300	3440	<b>3650(G)</b> <sub>153</sub>	3770	3890	<b>4000(H)</b> <sub>156</sub>	4130	<b>4250(J)</b> <sub>158</sub>
		lb.	6330	6660	6980	7280	7580	<b>8050(G)</b>	8310	8570	<b>8820(H)</b>	9100	<b>9370(J)</b>

NOTES: Letters in parentheses denote Load Range for which boldface loads and inflations are maximum.

International Load Index numbers are shown after Load Range.

IMPORTANT — Always use approved tire and rim combinations for diameter and contours.

# Commercial Light Truck Radials

Light Truck **METRIC** Radial Ply Tires for Trucks, Buses, Trailers & Multipurpose Passenger Vehicles Used in Normal Highway Service

## TIRES MOUNTED ON 5° DROP CENTER RIMS

TIRE SIZE DESIGNATION	USAGE	Tire Load Limits (lb.) at various Cold Inflation Pressures										
		kPa	250	275	300	350	380	400	450	480	500	550
		psi	35	40	45	50	55	60	65	70	75	80
LT245/70R17	DUAL	kg.	715	765	810	<b>900(C)</b> <sub>104</sub>	955	990	<b>1060(D)</b> <sub>110</sub>	1130	1160	<b>1250(E)</b> <sub>116</sub>
		lb.	1540	1690	1830	<b>1985(C)</b>	2105	2240	<b>2335(D)</b>	2495	2615	<b>2755(E)</b>
	SINGLE	kg.	785	840	890	<b>1000(C)</b> <sub>108</sub>	1050	1090	<b>1180(D)</b> <sub>114</sub>	1240	1270	<b>1360(E)</b> <sub>119</sub>
		lb.	1690	1855	2010	<b>2205(C)</b>	2315	2460	<b>2600(D)</b>	2740	2875	<b>3000(E)</b>
LT265/70R17	DUAL	kg.	800	855	910	<b>1030(C)</b> <sub>109</sub>	1070	1110	<b>1060(D)</b> <sub>110</sub>	1240	1260	<b>1320(E)</b> <sub>118</sub>
		lb.	1720	1890	2050	<b>2270(C)</b>	2360	2510	<b>2680(D)</b>	2735	2820	<b>2910(E)</b>
	SINGLE	kg.	880	920	1000	<b>1120(C)</b> <sub>112</sub>	1175	1220	<b>1215(D)</b> <sub>114</sub>	1360	1390	<b>1450(E)</b> <sub>119</sub>
		lb.	1890	2075	2255	<b>2470(C)</b>	2595	2760	<b>2910(D)</b>	3005	3100	<b>3195(E)</b>

TIRE SIZE DESIGNATION	USAGE	Tire Load Limits (lb.) at various Cold Inflation Pressures										
		kPa	250	280	310	350	380	410	450	480	520	550
		psi	35	40	45	50	55	60	65	70	75	80
LT225/75R16	DUAL	kg.	635	675	725	<b>800(C)</b> <sub>100</sub>	945	885	<b>975(D)</b> <sub>107</sub>	1000	1040	<b>1120(E)</b> <sub>112</sub>
		lb.	1365	1500	1630	<b>1765(C)</b>	1875	1995	<b>2150(D)</b>	2220	2330	<b>2470(E)</b>
	SINGLE	kg.	700	745	795	<b>880(C)</b> <sub>103</sub>	930	970	<b>1060(D)</b> <sub>110</sub>	1100	1140	<b>1215(E)</b> <sub>115</sub>
		lb.	1500	1650	1790	<b>1940(C)</b>	2060	2190	<b>2335(D)</b>	2440	2560	<b>2680(E)</b>
LT245/75R16	DUAL	kg.	720	765	820	<b>910(C)</b> <sub>104</sub>	960	1000	<b>1080(D)</b> <sub>111</sub>	1135	1170	<b>1260(E)</b> <sub>116</sub>
		lb.	1545	1695	1845	<b>2006(C)</b>	2125	2255	<b>2381(D)</b>	2515	2640	<b>2778(E)</b>
	SINGLE	kg.	790	840	900	<b>1000(C)</b> <sub>108</sub>	1055	1100	<b>1190(D)</b> <sub>114</sub>	1250	1290	<b>1380(E)</b> <sub>120</sub>
		lb.	1700	1865	2030	<b>2205(C)</b>	2335	2480	<b>2623(D)</b>	2765	2900	<b>3042(E)</b>
LT265/75R16	DUAL	kg.	810	860	920	<b>1030(C)</b> <sub>109</sub>	1080	1130	<b>1250(D)</b> <sub>116</sub>	1275	1310	<b>1400(E)</b> <sub>120</sub>
		lb.	1740	1910	2075	<b>2270(C)</b>	2390	2540	<b>2755(D)</b>	2825	2965	<b>3085(E)</b>
	SINGLE	kg.	890	950	1010	<b>1120(C)</b> <sub>112</sub>	1185	1240	<b>1360(D)</b> <sub>119</sub>	1400	1440	<b>1550(E)</b> <sub>123</sub>
		lb.	1910	2100	2280	<b>2470(C)</b>	2625	2790	<b>3000(D)</b>	3105	3260	<b>3415(E)</b>
LT225/75R17	DUAL	kg.	665	710	750	<b>850(C)</b> <sub>102</sub>	885	920	<b>1000(D)</b> <sub>108</sub>	1050	1070	<b>1150(E)</b> <sub>113</sub>
		lb.	1425	1565	1695	<b>1875(C)</b>	1950	2075	<b>2205(D)</b>	2310	2430	<b>2535(E)</b>
	SINGLE	kg.	730	780	825	<b>925(C)</b> <sub>105</sub>	970	1010	<b>1090(D)</b> <sub>111</sub>	1155	1180	<b>1250(E)</b> <sub>116</sub>
		lb.	1565	1720	1865	<b>2040(C)</b>	2145	2280	<b>2405(D)</b>	2540	2670	<b>2755(E)</b>
LT245/75R17	DUAL	kg.	750	805	850	<b>925(C)</b> <sub>105</sub>	1005	1040	<b>1150(C)</b> <sub>113</sub>	1190	1220	<b>1320(E)</b> <sub>118</sub>
		lb.	1610	1770	1920	<b>2040(C)</b>	2210	2350	<b>2535(C)</b>	2615	2750	<b>2910(E)</b>
	SINGLE	kg.	825	880	935	<b>1030(C)</b> <sub>109</sub>	1100	1140	<b>1250(D)</b> <sub>116</sub>	1305	1340	<b>1450(E)</b> <sub>121</sub>
		lb.	1770	1945	2110	<b>2270(C)</b>	2430	2580	<b>2755(D)</b>	2875	3020	<b>3195(E)</b>

NOTES: Letters in parentheses denote Load Range for which boldface loads and inflations are maximum.

International Load Index numbers are shown after Load Range.

IMPORTANT — Always use approved tire and rim combinations for diameter and contours.

# Commercial Light Truck Radials

Light Truck **METRIC** Radial Ply Tires for Trucks, Buses, Trailers & Multipurpose Passenger Vehicles Used in Normal Highway Service

TIRES MOUNTED ON 5° DROP CENTER RIMS												
TIRE SIZE DESIGNATION	USAGE	Tire Load Limits (kg./lb.) at various Cold Inflation Pressures										
		kPa	250	280	310	350	380	410	450	480	520	550
		psi	35	40	45	50	55	60	65	70	75	80
LT235/80R17	DUAL	kg.	730	800	830	925	1015	1010	1120	1090	1180	<b>1285(E)</b> <sub>117</sub>
		lb.	1570	1725	1870	2040	2190	2315	2470	2560	2685	<b>2835(E)</b> <sub>117</sub>
	SINGLE	kg.	800	880	910	1030	1115	1110	1215	1305	1300	<b>1400(E)</b> <sub>120</sub>
		lb.	1725	1895	2055	2270	2405	2545	2680	2815	2950	<b>3085(E)</b> <sub>120</sub>
LT215/85R16	DUAL	kg.	630	690	720	<b>800(C)</b> <sub>100</sub>	865	870	<b>975(D)</b> <sub>107</sub>	1025	1030	<b>1120(E)</b> <sub>112</sub>
		lb.	1360	1490	1625	<b>1765(C)</b>	1865	1985	<b>2150(D)</b> <sub>107</sub>	2210	2320	<b>2470(E)</b> <sub>112</sub>
	SINGLE	kg.	695	760	790	<b>880(C)</b> <sub>103</sub>	950	965	<b>1060(D)</b> <sub>110</sub>	1130	1130	<b>1215(E)</b> <sub>115</sub>
		lb.	1495	1640	1785	<b>1940(C)</b>	2050	2180	<b>2335(D)</b> <sub>110</sub>	2430	2550	<b>2680(E)</b> <sub>115</sub>
LT235/85R16	DUAL	kg.	720	790	820	<b>910(C)</b> <sub>104</sub>	985	1000	<b>1080(D)</b> <sub>111</sub>	1165	1170	<b>1260(E)</b> <sub>116</sub>
		lb.	1545	1700	1845	<b>2006(C)</b>	2125	2260	<b>2381(D)</b> <sub>111</sub>	2515	2645	<b>2778(E)</b> <sub>116</sub>
	SINGLE	kg.	790	965	900	<b>1000(C)</b> <sub>108</sub>	1100	1155	<b>1190(D)</b> <sub>114</sub>	1285	1290	<b>1380(E)</b> <sub>120</sub>
		lb.	1700	1870	2030	<b>2205(C)</b>	2335	2485	<b>2623(D)</b> <sub>114</sub>	2765	2905	<b>3042(E)</b> <sub>120</sub>

NOTES: Letters in parentheses denote Load Range for which boldface loads and inflations are maximum.

International Load Index numbers are shown after Load Range.

IMPORTANT — Always use approved tire and rim combinations for diameter and contours.

## Technical Bulletins

### Title

*Reference Number • Date*

<b>Truck/Bus Tire Tread Rubber Worn Color Appearance</b> .....	100
<i>T-16-10 • June 2016</i>	
<b>11-Digit DOT Number</b> .....	101
<i>TB-2000-01 • January 2000</i>	
<b>TBR Sidewall Repair &amp; Identification</b> .....	102
<i>T9106TD • April 1996</i>	
<b>Extra-Deep-Tread Tires' Lateral Stiffness Effects</b> .....	103
<i>T9502TI • October 1995</i>	
<b>Bridgestone Firestone Chassis Dynamometer Test Guides for Truck/Bus Tires</b> .....	104
<i>T9501X • October 1995</i>	
<b>Aftermarket Tire Products &amp; Additives in Truck/Bus Tires</b> .....	105
<i>TB-2008-001 • January 2008</i>	
<b>Aerosol Tire Sealer/Inflators</b> .....	106 - 107
<i>G-008-X • October 1991</i>	
<b>Innertube Storage</b> .....	108
<i>G-004-X • June 1991</i>	
<b>Mismatching Tire Bead &amp; Rim Diameters</b> .....	109 - 111
<i>T9106PD • August 1991</i>	
<b>Mounting Tubeless Truck Tires</b> .....	112
<i>T9101TD • December 1990</i>	
<b>Steam Cleaning Tires</b> .....	113
<i>T8701GD • October 1987</i>	

## Truck/Bus Tire Tread Rubber Worn Color Appearance

The tread rubbers of Bridgestone, Firestone, and Dayton brand truck/bus tires incorporate various technologies to optimize traction, wear, and other tire performance criteria.

For those tires engineered with dual tread compounds, once the outer tread rubber (commonly referred to as cap compound) has worn away, the base tread rubber will become exposed and may be apparent (see examples below). Depending on the design, the base rubber may have a lighter or darker appearance than the outer tread rubber. This color difference is a cosmetic condition as long as the tire is not damaged, has adequate tread depth, and there is no condition that requires further evaluation with a tire service professional or would make it necessary to remove it from service.

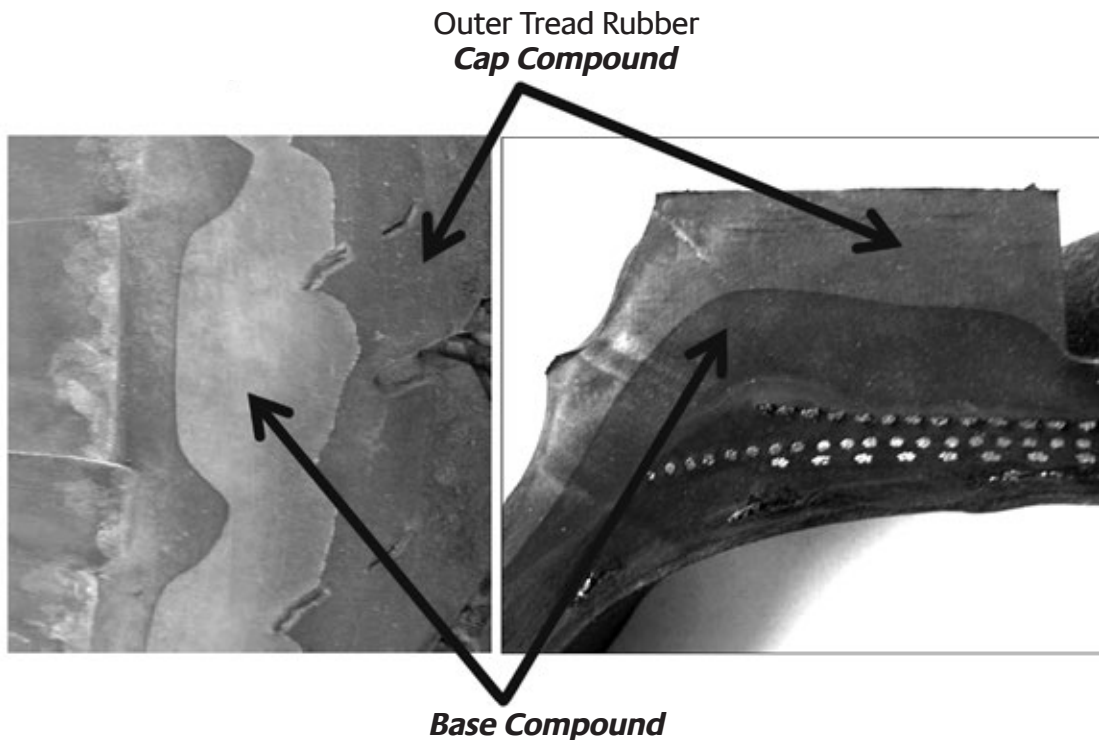

## 11 Digit DOT Number

The National Highway Traffic Safety Administration (NHTSA) has approved a change to the regulation that requires the date of manufacture in the tire identification number to change from 3 digits to 4 digits (2 digits for week + 2 digits for year.)

Bridgestone Firestone tire will start to adopt the new regulation for tires produced starting the first DOT week of 2000. Full integration of the 11 digit DOT serial number will be completed during the 2nd quarter of 2000.

Tire dealers will need to list the new 11-digit DOT serial number on Tire Registration Cards and Warranty Claim Forms (both forms have space for 11-digits.)

The new DOT Serial Number format:

<b>4D</b>	<b>HL</b>	<b>ABC</b>	<b>0508</b>
Plant Code	Size Code	Option Code	Date Mfg.

Ex: 5th week of 2008

## TBR Sidewall Repair & Identification

### **Background**

Radial truck tires can successfully be repaired in the sidewall area. When damaged body cord is removed and a reinforcing unit is used in the repair process, a radial sidewall bulge may be visible. In 1984, the Rubber Manufacturers Association (RMA) issued a bulletin stating that bulges up to  $\frac{3}{8}$ " in height are permitted when associated with these repairs.

### **Issue**

The Commercial Vehicle Safety Alliance (CVSA) is responsible for inspecting commercial vehicles for safety defects and placing vehicles out of service if defects such as tire separations or exposed cord/fabric are found. The inspectors, in the past have had difficulty distinguishing between sidewall bulges due to repairs (allowed) and tire separations.

### **Action**

In October 1990, the CVSA agreed to accept the use of a blue triangular identification adjacent to a sidewall repair bulge. A vehicle will not be placed out of service if a tire repair bulge is  $\frac{3}{8}$ " or less in height and is identified with an adjacent blue triangle. The retread and repair industry will be incorporating these identification patches into their sidewall repair procedures.

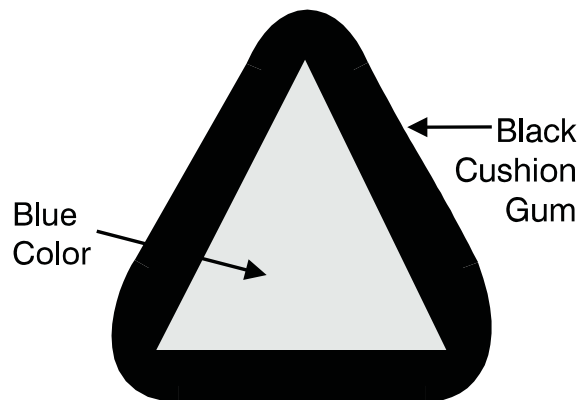

Sample Triangular Identification Patch

Note: Actual Size

## Extra-Deep-Tread Tires' Lateral Stiffness Effects

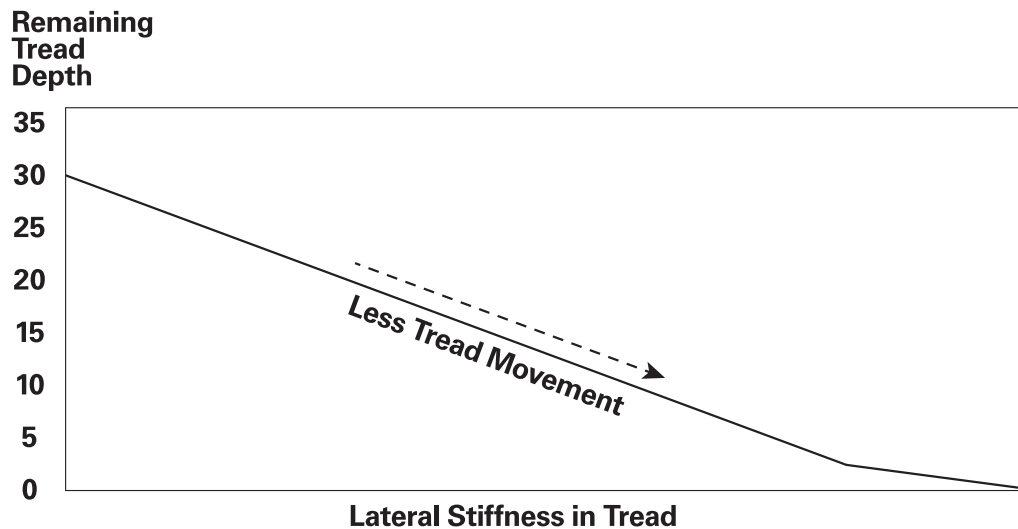

**M**any drivers are aware of the feel of the trucks used on a daily basis in fleets, and are sometimes sensitive to the ride dynamics of fitment changes of new tire designs on the vehicle.

One of the sensations drivers notice is a side-to-side motion. This motion is the byproduct of what is commonly referred to as lateral stiffness.

The lateral stiffness of a tire is due in large part to inflation pressure, as well as the tire's tread depth. Both of these factors vary over time. Reduced inflation pressure and deeper tread depth results in lower lateral stiffness.

Therefore, some users may comment on experiencing a slight swaying with newly installed extra-deep-tread drive tires, especially under full load or after replacing worn drive tires.

The sensation the driver feels is the lateral stiffness effect of the extra-deep-tread drive tire compared to the worn tire being replaced and does not affect traction or warrant any concerns.

The lateral stiffness improves quickly as the tread wears and a driver will become accustomed to the initial difference in sensation.



## Bridgestone Firestone Chassis Dynamometer Test Guidelines for Truck/Bus Tires

### *I. Background*

Vehicle manufacturers and many maintenance facilities conduct in-place vehicle testing on twin-roll chassis dynamometers. Testing is usually conducted over a short period of time on empty vehicles. If the following procedure is not adhered to, irreversible damage may occur to the tire.

### *II. Procedure*

To prevent excessive head buildup in the center of the tire tread, follow the recommended time period based on roller diameter as listed below:

Maximum Allowable Time by Roller Diameter	
8-5/8" Roller	18" Roller
3.5 minutes	6 minutes

Maximum Allowable Speed is 55 mph.

**Load:** These time restrictions apply regardless of the actual load and are, in fact, more critical when the vehicle is tested without a load.

### *III. Precautions*

To avoid the possibility of irreversible tire damage and/or failure during testing, it is important that the following precautions be taken:

- Do not exceed the time and speed restrictions listed in part II.
- Allow at least one hour cool down between tests.
- When it is anticipated that a test will exceed the time/test value established, a worn or "slave" tire should be used in place of the new tire for testing purposes.

Questions regarding test procedures, loads, etc. should be directed to your Regional Field Engineering Office.



Example of Dyno Damage

## **Aftermarket Tire Products & Additives in Truck/Bus Tires**

Bridgestone Firestone does not endorse or prohibit the use of aftermarket tire products. The use of internally applied additives for balance, sealing, cooling, or any other alleged tire performance enhancement in Bridgestone or Firestone brand truck/bus tires will not void the Limited Warranty unless an inspection of the tires reveals damage related to the use of the additive.

## Aerosol Tire Sealer/Inflators

Aerosol tire sealer/inflators have been used by large numbers of motorists each year and an undetermined number of tires now on the road, which have been filled with these devices, may have combustible gases in their air chambers.

Please read carefully and make sure all your employees read the attached publications that have been approved and distributed by the Rubber Manufacturers Association and the National Highway Safety Administration.

### TIRE OR RIM REPAIR SAFETY BULLETIN

#### FACTS YOU SHOULD KNOW...



It is difficult to determine whether a tire has been inflated with a flammable aerosol type tire sealer/inflator. Therefore, if your establishment repairs or works on rims or on pressurized, rim-mounted tires, you should handle all of them as if they contain a flammable tire sealer-inflator.

The gases in the sealer/inflator, which can be poisonous, are combustible inside the tire. An explosion can occur if ANY ignition source is present. Even the insertion of a plug into a steel-belted tire could cause an explosion!



Proper safety precautions to avoid ignition of flammable gases **MUST** be followed during the repair or maintenance of ALL tires or rims.

Failure to follow these precautions and procedures may result in serious or even fatal injury.

#### PRECAUTIONS YOU SHOULD TAKE...



All tires should be handled as if a flammable tire sealer has been used. Do not rely upon the customer, even if he advises you that one has not been used. Customers may neglect to tell you or even may have forgotten they used a sealer/inflator.



Always make sure that the repair area is well-ventilated so that any gases that are present will not accumulate.



Never weld or use a cutting torch on a wheel or rim without first completely removing the tire from the rim. Otherwise, explosions resulting in possible serious or fatal injury can occur, even in the absence of flammable sealer/inflator.



Do not use a tire rasp, plug or any object which could cause sparks on a tire or rim without first completely removing the tire from the rim. These ignition sources could lead to an explosion.



Do not permit smoking or any flame, spark or other ignition source in the area where tires or rims are being kept.



Never add air to a tire treated with a flammable sealer/inflator without completely removing the flammable gas. Air added to a tire containing flammable gas may make it more explosive.

#### **BEFORE BEGINNING REPAIRS OR SERVICE ON ANY RIM OR TIRE, YOU SHOULD ALWAYS FOLLOW THESE SAFETY PROCEDURES:**

Remove the valve stem completely to release the tire pressure in a well-ventilated area, away from sparks or other ignition sources.

After the pressure has been released and before making any repairs, remove the tire from the wheel rim.



If you believe a sealer/inflator has been used, wash the inside of the tire with a detergent/water solution and rinse thoroughly. Allow the tire to dry before repairs are made.



U.S. Department of  
Transportation

## News:

Office of the Assistant Secretary for Public Affairs  
Washington, D.C. 20590

**FOR IMMEDIATE RELEASE**  
Tuesday, September 24, 1991

**CONSUMER ADVISORY**

NHTSA 49-91  
Contact: Shipp Calvert  
Barry McCahill  
Tel. No.: (202) 956-9550

### NHTSA WARNS ABOUT HAZARDS OF FIXING TIRES FILLED WITH AEROSOL INFLATORS

The National Highway Traffic Safety Administration (NHTSA) today cautioned motorists and urged workers at service stations and auto and tire repair shops to be careful while fixing tires that have been filled with aerosol inflators.

According to NHTSA Administrator Jerry Ralph Curry, many of the aerosol inflators contain a flammable propellant that can cause an explosion under certain circumstances. "People in the tire repair business especially should be aware of the hazard and take precautions to reduce the risk of an explosion," he said.

Aerosol inflators, marketed under various brand names, are widely sold to the public for temporarily fixing tires that have gone flat because of slow leaks and small punctures, Curry said.

He said that despite flammability warnings on the cans and instructions for safe use, many consumers may be unaware of the potential danger. "Aerosol flat tire fixes should be considered as emergency, temporary repairs and used with caution. It is always preferable to have the tire repaired professionally or replaced.

"After filling a tire with an aerosol inflator, don't expose the tire to extreme heat, flames, sparks or other ignition sources. Be careful using metal tools like tire irons, metal reamers and hammers because they could cause sparks while being used to repair a tire," Curry said.

He noted that because aerosol inflators are used so commonly, consumers and service personnel should assume a tire may have been repaired previously with an aerosol product. "Before starting to fix a tire, remove the valve core and completely deflate the tire to eliminate as much of the aerosol propellant as possible. Then, inflate and deflate the tire a few times to completely remove all traces of the potentially explosive propellant. Once this is done, you may repair the tire without risk of explosion," Curry said.

###

## **Innertube Storage**

Innertubes should always be stored in a sealed enclosure. If the seal is damaged or broken, reseal the enclosure or repackage the affected tubes to prevent premature ozone crack damage on tubes. Exposure to weather, open doors, sunlight, electric motors and fans can cause premature aging of the rubber compound, especially when folded. In addition, tubes stored in tires can be similarly affected if unprotected by a flap or rim.

**Tubes with ozone crack damage should be replaced.  
Do not place these in service.**

## Mismatching Tire Bead & Rim Diameters

**T**here is danger in installing a tire of one rim diameter on a rim of a different rim diameter.

Always replace a tire on a rim with another tire of exactly the same rim diameter designation and suffix letter.

For example a 16" tire goes with a 16" rim. **Never mount a 16" size diameter tire on a 16.5" rim.** While it is possible to pass a 16" diameter tire over the lip or flange of a 16.5" size rim diameter, it cannot be inflated enough to position itself against the rim flange. If an attempt is made to seat the tire bead by inflation, the tire bead will break with explosive force and could cause serious injury or death.

Various materials have been published on the importance of properly matching tire bead and rim diameters prior to attempting to mount the assembly. Listed below is a sampling of that material.

### **Bridgestone:**

#### **1. Technical Bulletin #T9104TD**

##### **Sec. V Tire and Rim Matching Importance**

Remember the importance of proper matching of tires and rims. In particular, special care must also be used in the mounting of any 16" diameter tire sizes, as well as the 15.5" and 17.5" sizes. The 16" size tire must be mounted only

on the approved 16" rims and not the 15.5" or 16.5" rims. In addition, any 15" size tire must be mounted only on approved 15" rims not on the 15.5" rim and any 17" size tire must be mounted only on approved 17" rims not on the 17.5" rim.

If mounting of a 15" diameter tire is attempted on a 15.5" rim, or a 16" tire is attempted to be mounted on a 16.5" rim, or a 17" tire is attempted to be mounted on a 17.5" rim, serious injury or death may result.

#### **2. Tire Label Safety Warning**

##### **Safety Warning**

- Serious injury or death may result from an explosion of tire/rim assembly due to the use of excessive pressure during mounting.
- Never exceed 40 psi (275 kpa) to seat beads. After beads are seated, adjust inflation to pressure recommended by vehicle manufacturer.
- During tire inflation, always have assembly secured, stand clear, and use remote controlled clip on air hose.
- Only specially trained persons should mount tires.
- Mount only on 16 inch\* diameter rims.

*\*Warning: Varies by tire size.*

**1/3** continues >>>

### 3. Molded Sidewall Safety Warning

#### Safety Warning: Serious Injury may result from:

- Tire failure due to inflation/overloading — follow owner's manual or tire placard in vehicle.
- Explosion of tire/rim assembly due to improper mounting — never exceed 40 psi (275 kpa) to seat beads — mount only 16 inch diameter rims\* — only specially trained persons should mount tires.

\*Warning: Varies by tire size.

### Rubber Manufacturer Association (RMA)

#### 1. Care and Service of Automobile and Light Truck Tires \*

\* Copies from the RMA material can be ordered from:  
Rubber Manufacturers Association  
1400 K Street N.W.  
Washington, D.C. 20005

### WARNING

There is danger in installing a tire of one rim diameter on a rim of a different diameter.

Always replace a tire on a rim with another tire of exactly the same rim diameter designation and suffix letter.

For example a 16" tire goes with a 16" rim. Never mount a 16" size diameter tire on a 16.5" rim. While it is possible to pass a 16" diameter tire over the lip or flange of a 16.5" size rim diameter, it cannot be inflated enough to position itself against the rim flange. If an attempt is made to seat the tire bead by inflation, the tire bead will break with explosive force and could cause serious injury or death.

Rims of a different diameter and tapers cannot be interchanged. The following diagram illustrates the difference between rims of two different tapers and diameters:

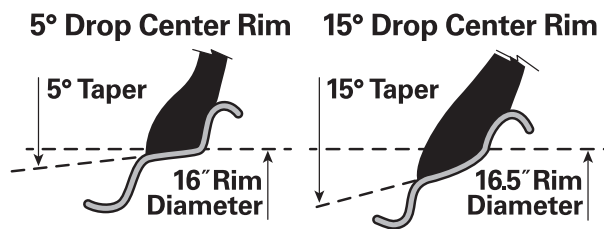

The following diagram shows how the beads of a 16" tire will not seat on a 16.5" rim. The beads cannot be forced out against the rim flanges by using more air pressure, because this will break the beads and the tire will explode.



Mismatching Tire Bead & Rim Diameters **2/3** continues >>>

**WARNING**

**Never inflate beyond 40 pounds pressure to seat beads.**

**Never stand, lean or reach over the assembly during inflation.**

Inspect both sides of the tire to be sure that the beads are evenly seated. If tire mounted on a machine that does not have a positive lock-down devices to hold the wheel, inflation should be done in a safety cage. If both beads are not properly seated when pressure reaches 40 pounds, completely deflate the assembly, reposition the tire and/or tube on the rim, relubricate and reinflate. Inflating beyond 40 pounds air pressure when trying to seat the bead is a DANGEROUS PRACTICE that may break a tire bead (or even the rim) with explosive force, possibly resulting in serious injury or death. After the beads are fully seated, pressure may be increased above 40 psi to operating pressures, not to exceed the maximum labeled on the tire sidewall.

**WARNING**

**Serious Injury May Result From:**

- **Tire failure due to underinflation/overloading – follow owner’s manual or tire placard in vehicle;**
- **Explosion of tire/rim assembly due to improper mounting – only specially trained persons should mount tires.**

**WARNING**

**Tire changing can be dangerous and should be done by trained personnel using proper tools and procedures. Always read and understand any manufacturer’s warning contained in their customer’s literature or molded into the tire sidewall.**

Failure to comply with these procedures may result in faulty positioning of the tire and/or rim parts, and cause the assembly to burst with explosive force, sufficient to cause serious physical injury or death. Never mount or use damaged tires or rims.

**2. “Demounting and Mounting Procedures for Automobile Tires” (Wallchart)\***

**3. “Tire Replacement Guide for Light Trucks” (Wallchart)\***

**Consumer Inquires:**

If questioned by a consumer on this matter, it is recommended that you stress the following areas:

1. Bridgestone tires are designed with adequate strength to withstand mounting and demounting stresses when correctly matched to rims of the correct diameter.
2. All Bridgestone 16” and 16.5” tires carry a safely warning permanently molded into the tire sidewall which directs trained personnel to mount only the approved matching rim (example: “Mount only on 16 inch diameter rims.”)\*

*\*Warning: Varies by tire size.*



## Mounting Tubeless Truck Tires

Proper mounting practices are mandatory to help ensure uniform tire/wheel assemblies for application to heavy duty trucks which use 22.5 and 24.5 bead diameter tubeless truck tires. Failure to follow the industry recommendations for mounting uniformity may result in improper tire bead/wheel fit and can lead to vehicle vibration and irregular tire wear.

Bridgestone recently conducted a tire mounting study involving tubeless tires of different brands, aspect ratios and bead diameters on new and used steel and aluminum wheels. Bridgestone tires included in this study were R299, R194-LP, R293 and R194 designs.

Results of the evaluation showed that regardless of the item combination checked, uniform assemblies were obtained when the following three practices were performed:

1. Clean the wheel or rim
2. Lubricate the tire and beads  
AND WHEEL/RIM BEAD SEAT
3. Check the assembly for concentricity

1. A used wheel/rim should be cleaned by wire brushing to remove rust, scale and build-up. Painting the cleaned metal with primer or anti-rust paint is recommended.
2. Before assembling tire and wheel/rim, lubricate tire beads and wheel/rim seat with a vegetable oil-based lubricant formulated for tire and wheel/rim use. Do not use petroleum- or solvent-based products, as they cause rubber deterioration.

Failure to lubricate the wheel/rim as well as the tire can lead to a non-uniform assembly.

The best initial balance is obtained by matching the tire's light spot (marked by a yellow dot or circle) at the wheel/rim valve.

3. To check the assembly for concentricity of a tire and wheel/rim, measure the distance between the tire-flange interface and the circumferential ring molded into the

tire sidewall at four locations (90 degrees apart) around the tire-flange circumference. Distances measured should be within a 2/32" (1.5 mm) range for acceptable uniformity. If the ranges in distance within the same side of the tire are greater than this, break down assembly, re-lubricate and remount the tire.

Following these practices will reduce vehicle vibration and irregular wear occurrences. The first step in investigating these types of complaints should be the measurement of tire and wheel/rim concentricity to determine if non-uniform mounting is present, and the probable cause. If so, break down assembly, re-lubricate tire and wheel and remount tire.

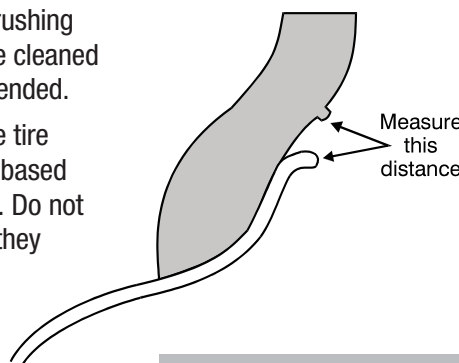
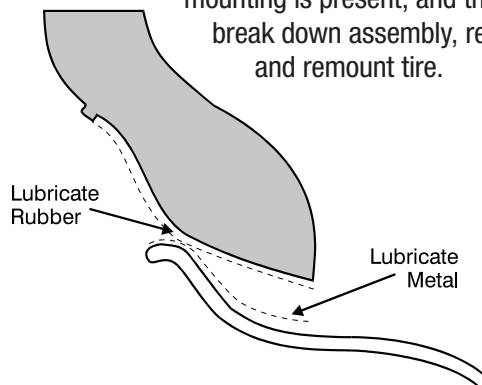

**REMEMBER:  
CLEAN! LUBRICATE! CHECK!  
AND ALWAYS FOLLOW ALL  
OSHA, RMA, AND MANUFACTURER  
MOUNTING SAFETY PRECAUTIONS!**

## **Steam Cleaning Tires**

**CAUTION:** Steam cleaning can damage a tire and render it unserviceable.

At many businesses throughout the United States, it is common practice to use "steam cleaning equipment" to wash trucks and tires.

Nozzle temperature on steam cleaning equipment typically reaches 280°F.

When a steam cleaning nozzle is held too close to the sidewall of a tire for as short a time as 45 seconds, a small spongy blister may appear on the sidewall. When this blister is cut open, one will observe reverted rubber resulting from the excessive localized heat.

Steam cleaning of tires can be harmful to tires when the nozzle is concentrated in one spot for a period of time.



## R283A Ecopia®

An all-position radial recommended for steer applications in long haul and regional haul service. EPA SmartWay® verified and CARB compliant.

**Replaces:**

Goodyear **Fuel Max LHS**  
Michelin **XZA3+, X Line Energy Z**



## R283s Ecopia®

A steer radial for long haul and regional haul service. Defense Side Groove minimizes shoulder wear, and Equalizer Ribs to promote uniform wear. EPA SmartWay® verified and CARB compliant.

**Replaces:**

Goodyear **Fuel Max LHS**  
Michelin **XZA3+, X Line Energy Z**



## R227F

Unidirectional tread pattern and high-performance tread compounds, along with Side Groove™ and Equalizer Rib™ technologies promote improved fuel economy, long mileage, and outstanding wet traction in all line haul applications.

**Replaces:**

Michelin **XZA, XZE2+**



## R268 Ecopia®

A fuel-efficient all-position radial enhanced to resist maneuvering scrub. Recommended for regional haul service, and pickup and delivery service. EPA SmartWay® verified and CARB compliant.

**Replaces:**

Goodyear **G662, G661**  
Michelin **XZE, XZE2, XZE2+, X Multi Energy Z**



## R238

Resistant to tread scrubbing with protective sidewall ribs, and wide solid shoulder increases tread life. Recommended for regional service, and pickup and delivery service.

**Replaces:**

Goodyear **G647 Endurance RSA**  
Michelin **XZE**



## R250 ED

A five-rib design featuring wide, rounded shoulders, straight grooves and sidewall protector ribs for high-scrub regional service.

**Replaces:**

Goodyear **G661, G662**  
Michelin **XZE, XZE2, XZE2+**



## M710 Ecopia®

A drive radial recommended for tandem axle drive applications in long haul and regional haul service. EPA SmartWay® verified and CARB compliant.

**Replaces:**

Goodyear **G505D, G305**  
Michelin **XDA Energy, X Line Energy D**



## M760 Ecopia®

A SmartWay® verified drive radial with extensive lug and shoulder siping to improve traction on wet and dry surfaces. Recommended for high traction and high scrub applications.

**Replaces:**

Goodyear **G572A**  
Michelin **X Multi Energy D**



## M726 ELA

Improved for longer wear life and lower rolling resistance for greater fuel efficiency. Up to 32/32" tread depth drive tire with solid shoulders and aggressive inner blocks to provide long, even wear and high traction.

**Replaces:**

Goodyear **G362, G622 RSD**  
Michelin **XDA5, XDN2**



## M726

Extra-deep drive tire with solid shoulder ribs delivers long tread life, maximum traction and even wear.

**Replaces:**

Goodyear **G622**  
Michelin **XD2**



## M749

A drive radial designed with stable footprint for long even wear, and reliable traction. Flexible groove fence reduces road noise. Recommended for auto haulers and long haul service.

**Replaces:**

Michelin **X MultiWay XD**



## Greatec® M835A Ecopia®

A wide base radial recommended for tandem axle drive applications in long haul service.

EPA SmartWay® verified and CARB compliant.

**Replaces:**

Goodyear **G392 SSD**  
Michelin **X One Line Energy D**



## M770

An open-shoulder single drive axle radial tire providing high traction for high scrub applications in long haul, regional and pickup and delivery service.

**Replaces:**

Goodyear **G338**

Michelin **XD4, XDN2, XDE M/S**



## M799

A mixed service open shoulder drive axle radial tire for vehicles including dump trucks, and occasional use on gravel roads and construction sites.

**Replaces:**

Goodyear **G182**

Michelin **XDE M/S**



## M729F

A drive radial featuring casing construction and cap/base compounding designed to improve durability and retreadability. Recommended for high traction and high scrub applications.

**Replaces:**

Goodyear **G622**

Michelin **XDE2+, XDS2**



## M895

All-position radial with block design and sure handling to help reduce noise and wander, even on highways with rain grooves. Recommended for steer and drive positions in metro or urban applications.

**Replaces:**

Goodyear **G622**

Michelin **XDS2**



## M724F

An all-position, all-season radial recommended for steer and drive positions. Features sidewall protector ribs for resistance to curb damage.

**Replaces:**

Goodyear **G622, G633**

Michelin **XDS2, XDE2+**



## R197 Ecopia®

An all-position radial recommended for single and tandem axle trailer and dolly applications in long haul and regional haul service.

EPA SmartWay® verified and CARB compliant.

**Replaces:**

Goodyear **G316 LHT**

Michelin **X Line Energy T**



## R196

A five-rib radial recommended for high-scrub, free-rolling axles such as spread axles and tri-axle trailers.

**Replaces:**

Goodyear **G619, G661**

Michelin **XTE**



## Greatec® R197 Ecopia®

Delivers 6% better rolling resistance, & up to 20% longer removal miles than previous generation tires (shown in tests). A wide base radial recommended for tandem axle trailer applications in long-haul service.

**Replaces:**

Goodyear **G394 SST**

Michelin **X One XTA**



## R180

Five-rib design helps to provide sure traction on wet surfaces for pickup and delivery applications.

**Replaces:**

Goodyear **G114**

Michelin **XZA**

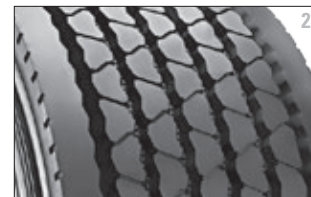

## Greatec® M845

A wide-base tread featuring next-generation WavedBelt™ design for improved irregular wear performance and exclusive Turn In Ply™ bead for enhanced retreadability.

**Replaces:**

Michelin **X One XZUS**

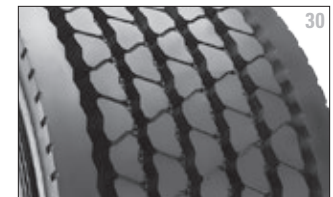

## Greatec® M853

A wide-base tread — tough and long-lasting in severe service applications. Features optimized WavedBelt™ technology for improved wear, Turn In Ply™ bead for enhanced retreadability, and special tread compounds to prevent cuts and stone drilling.

**Replaces:**

Michelin **X One XZUS**



## M860A

Wide tread to enhance handling and deep tread depth for longer mileage. Sidewall protectors resist scrubbing and curbing. Stone rejectors help protect casing from damage.

**Replaces:**

Goodyear **G287, G289**  
Michelin **XZUS2, XZUS, XZY3**



## M853

An on/off-highway all-position radial tire suitable for vehicles subject to occasional use on gravel roads and construction jobsites.

**Replaces:**

Goodyear **G287, G289**  
Michelin **XZY3**



## M843

Extra-deep rib-lug radial recommended for use on all wheel positions in all on/off-highway applications. Resists cuts, tearing, and irregular wear.

**Replaces:**

Goodyear **G287, G288**  
Michelin **XDS, XDS2**



## M840

An all-position on/off-highway radial. Tread compound features anti-chip and cut capability for use on unimproved roads.

**Replaces:**

Goodyear **G288**  
Michelin **XZY, XTY2**



## M857

A rib-lug tread design for use on all wheel positions in on/off-highway applications such as dump trucks, logging rigs, and refuse haulers.

**Replaces:**

Goodyear **G286**



## L320

A deep-tread, high-traction lug design for drive axles in on/off-highway service. Special tread compounds are cut-, chip-, tear- and irregular wear-resistant.

**Replaces:**

Goodyear **G177, G282**  
Michelin **XDY3, XDY-EX2, XDL**



## M775

A deep-tread drive axle on/off-highway tire, recommended for the special demands of the logging and construction industries.

**Replaces:**

Goodyear **G177, G282**  
Michelin **XDY3, XDY-EX2, XDL**

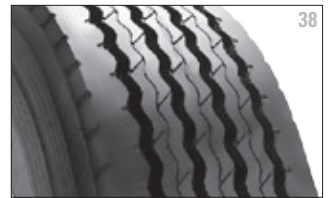

## R244

A wide base drive designed to deliver a smooth ride with a higher payload. Optimized casing and belt package to resist irregular wear.

**Replaces:**

Goodyear **G296 MSA**  
Michelin **XFE**



## M854

Tread pattern designed for aggressive traction in on/off-highway service. Special tread compounds help deliver longer wear life and provides resistance to irregular wear and cuts.

**Replaces:**

Goodyear **G296**  
Michelin **XZY3**



## L315

An on/off-highway wide base tire recommended for drive axles carrying extra heavy loads, with special tread compounds that are cut-, chip-, tear- and irregular wear-resistant.

**Replaces:**

Goodyear **G178, G286, G296**  
Michelin **XZY3**



## L317

A deep-tread off-highway, high-traction lug design for drive axles. Tread compound is cut- and chip-resistant.

**Replaces:**

Goodyear **G177**  
Michelin **XDL, XZL**

TIRE CARE & SERVICE TIPS  
FOR COMMERCIAL TRUCK TIRES

- » **Do not exceed your tire's maximum recommended speed which may be lower than posted speed limits**
- » **Select the right tire for the job considering the proper tire size, load carrying capacity, speed capability and service type**
- » **Set and maintain proper cold inflation pressures**
- » **Inspect your tires frequently for damage such as cuts, cracks, bulges and penetrations**

# BRIDGESTONE TECHNICAL SERVICE

## (800) 847-3272



### WEST

2500 South Doubleday  
Ontario, CA 91761

### CENTRAL

2100 Internationale Pkwy  
Woodridge, IL 60517

### EAST

201 Bridgestone Pkwy  
Lebanon, TN 37090

### HOME OFFICE

(615) 937-1000

4th Avenue South  
Nashville, TN 37204

#### Bridgestone Commercial Solutions

For your nearest Bridgestone Authorized Dealer,  
visit our website

[www.BridgestoneTrucktires.com](http://www.BridgestoneTrucktires.com)

TE 06190005 ©2018 Bridgestone Americas Tire Operations, LLC. All Rights Reserved.